



Complete Freeze Protection for Process Instrumentation

Totaal pakket voor de vorstbeveiliging van uw proces instrumentatie

Protection-basse température complète pour l'instrumentation

Kompletter Frostschutz für Prozess-Instrumentierung

Completa protezione antigelo per strumentazione di processo

Komplett frostsikring av prosess instrumenter

Комплексная морозная защита приборов и процессных линии КИПиА

Completa Protección Contra Congelacion Para Instrumentacion de Proceso

VIPAK[®]

Design | Enclosures | Supports | Tubing Bundle | Installation

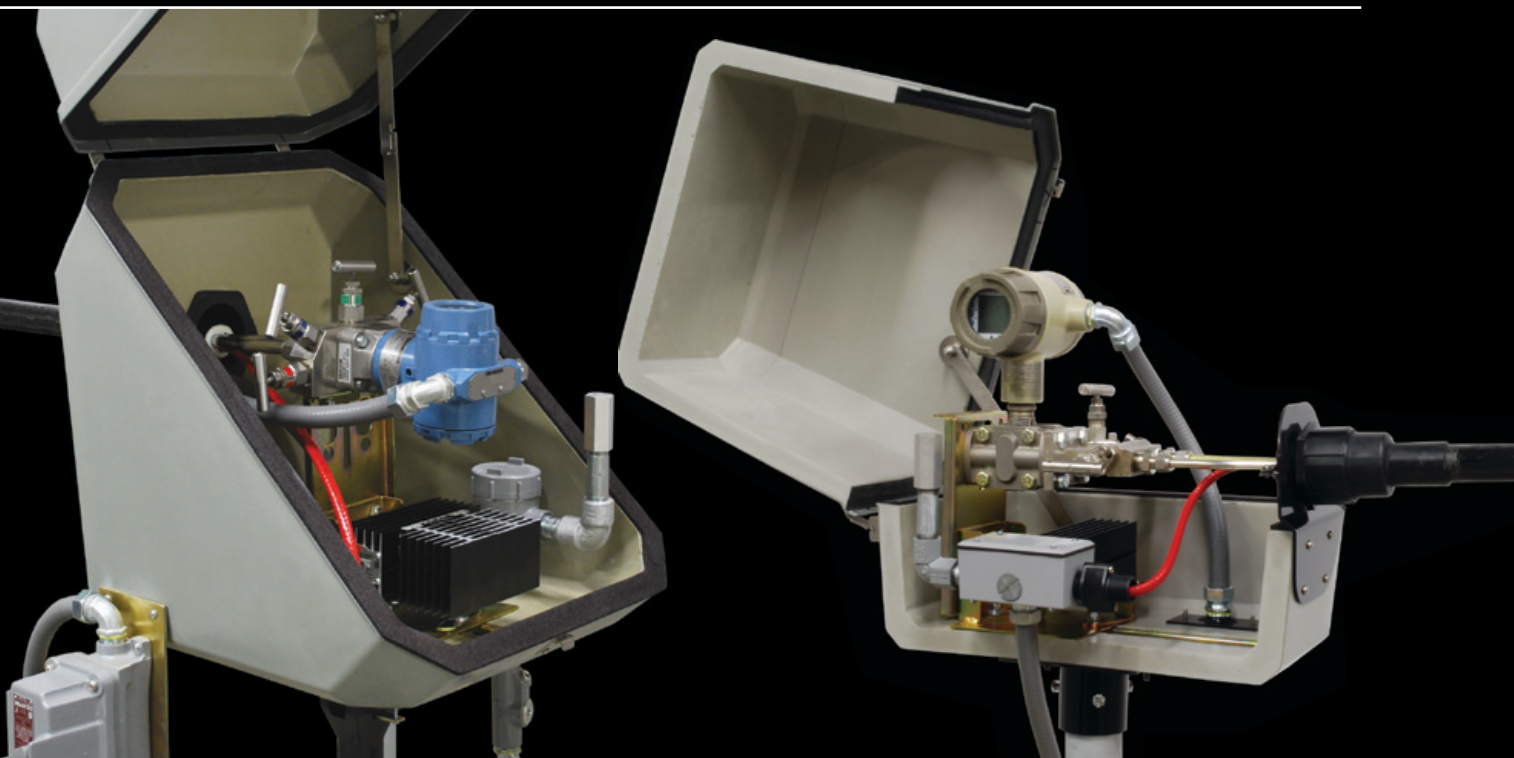

O'BRIEN PROVIDES COMPLETE FREEZE PROTECTION FOR PROCESS INSTRUMENTATION

Protecting instrumentation and tubing from freezing or maintaining process fluids at elevated temperatures involves many components, designs and engineering skills. Instead of specifying and purchasing individual components, have O'Brien provide an integrated solution with one source responsibility.

The typical way.

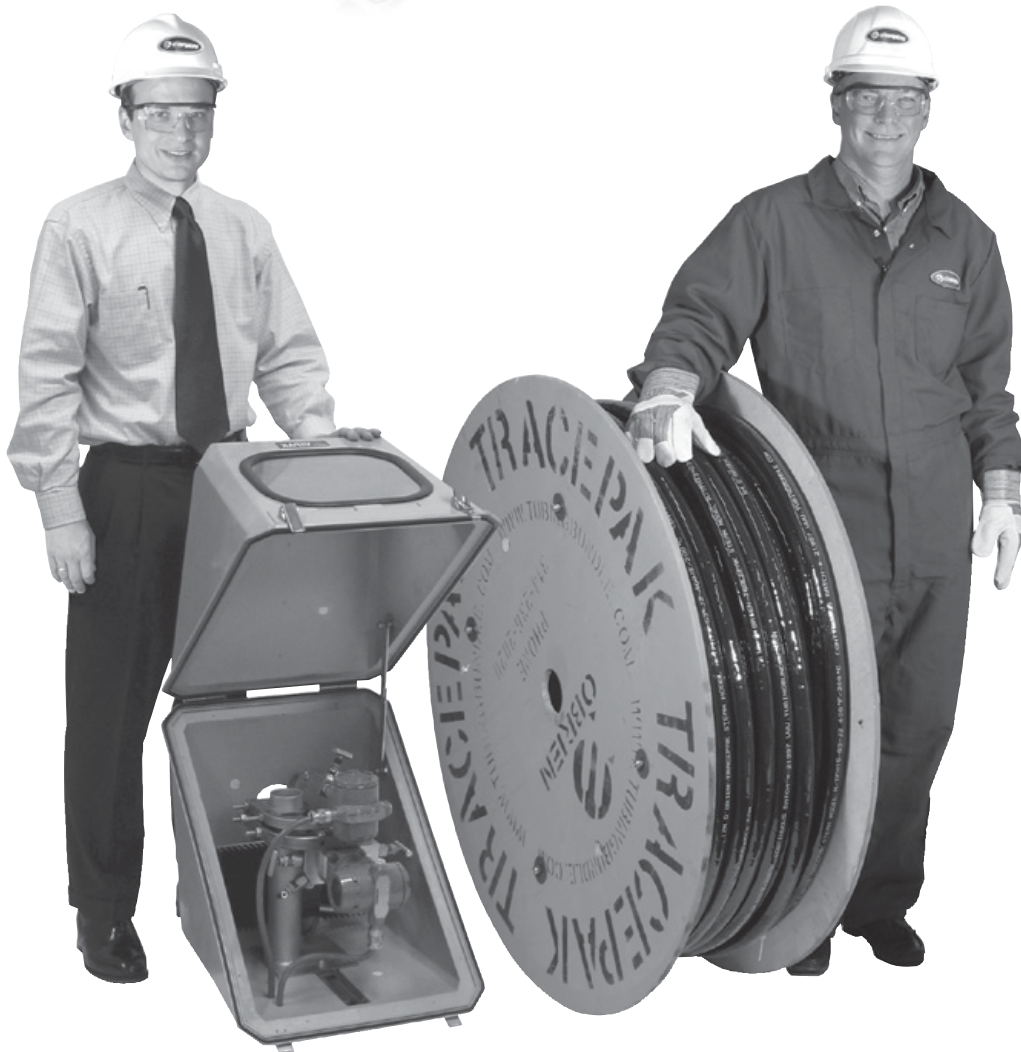
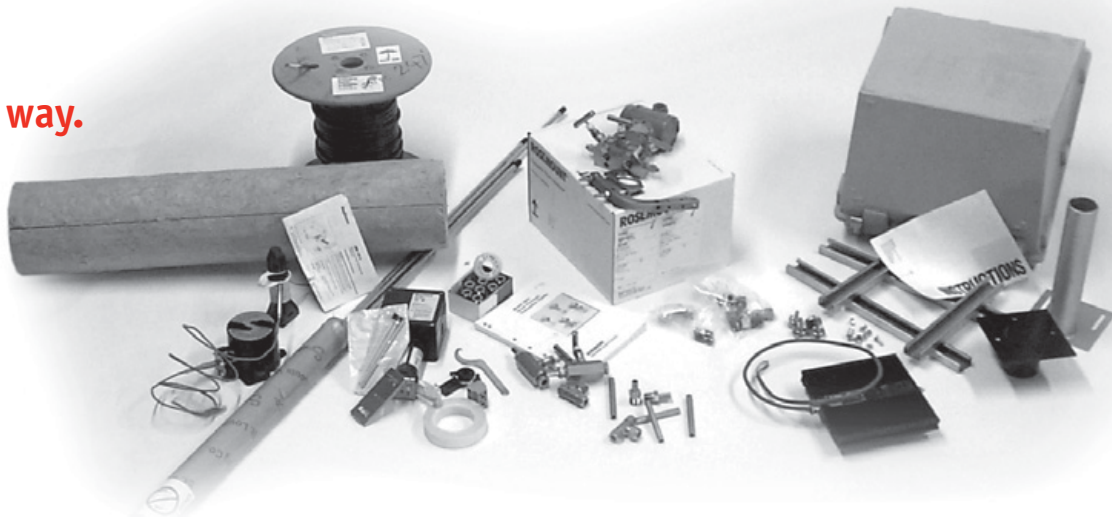

DESIGN and SUPPORT

One source responsibility for design, impulse lines, and instrument freeze protection combined with field support services sets the O'Brien solution apart from all others.

TRACEPAK®

Engineered, pre-traced and insulated tubing bundle for instrument impulse, sample transport, and small diameter process lines.

VIPAK®

Engineered enclosure system designed for process instrumentation. TRAKMOUNT® and factory installation of instrumentation makes field work easy.

The O'Brien solution.

A complete system

The VIPAK enclosure system winterizes process instruments and protects them from corrosion and mechanical abuse. A full range of enclosure sizes are available to accommodate single and multiple instrument requirements. Enclosures can be combined with a wide selection of heavy-duty mounts, brackets and heaters to create customized packages that suit each application.

Easy to install

Process instrumentation fastens directly to O'Brien mounting kits and process connections line up with factory mounted parting plates for quick, easy installation.

Easy to order

- 1 Select an enclosure style and size. Choose standard construction or anti-static option.
- 2 Add a mounting kit or individual mount and bracket.
- 3 Add an electric or steam heater.
- 4 Add entry fittings, plates, connections and other options to complete the package.
- 5 Select TRACEPAK® pre-insulated tubing bundle configuration.

Protects instruments from:

- Corrosion
- Chemical attack
- Mechanical abuse
- Freezing and Weather

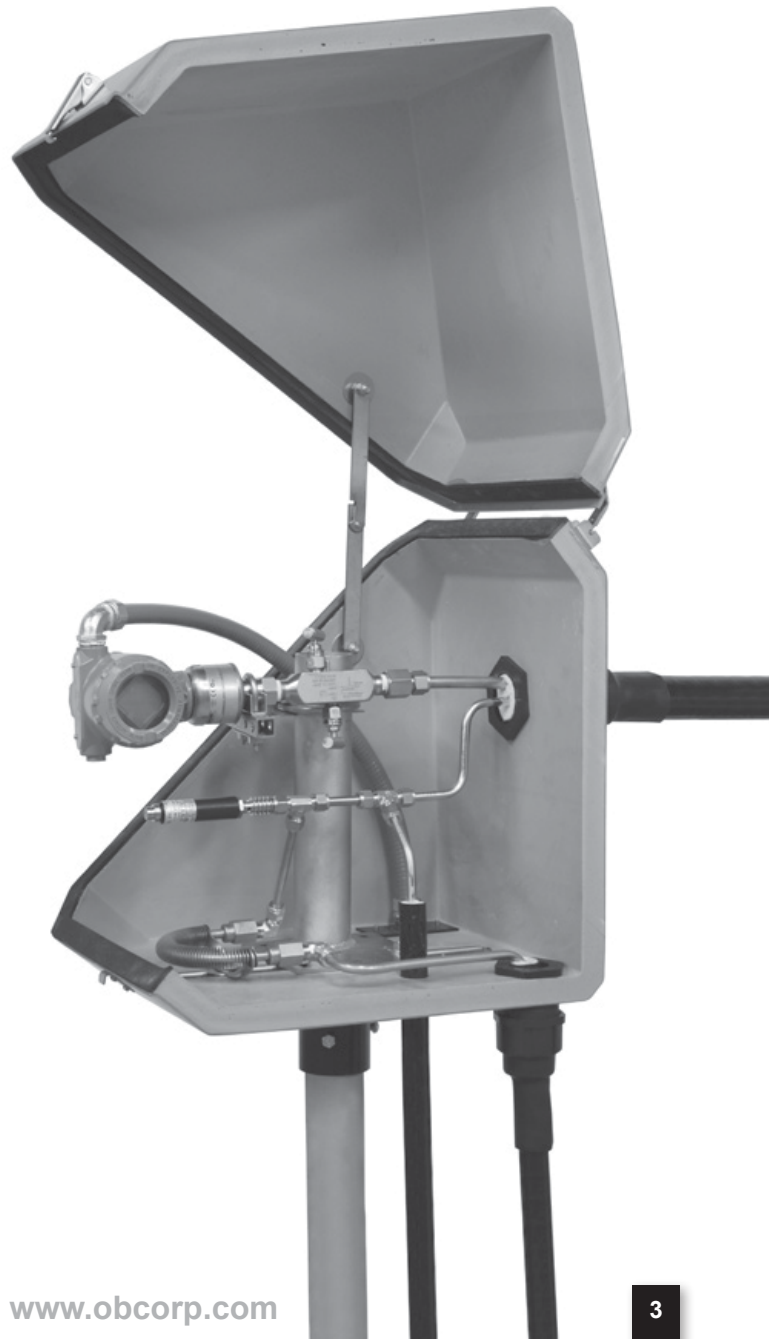

ENCLOSURE FEATURES

Factory installed accessories - heaters, windows, mounts, bracketry

Impact Resistant EN50014 / BS5501

VIPAK's rigid ABS shell forms a structural bond with medium density urethane foam insulation to provide a durable enclosure that remains impact resistant for years, even at low ambient temperatures.

Anti-static Option EN50014 / BS5501



Corrosion & UV Resistant ABS Shell

Insulation

1" (25mm) thick ABS/Urethane composite.

Metal-to-Metal Support

VIPAK's unique thru-bolt construction, with metal spacers between the enclosure mount and the instrument bracket, provides a solid support for instruments and accessories.



Weather Protection IP66

Parting lines are protected by a molded flange and sealed with closed cell neoprene gasket. Windows are sealed with silicone adhesive to guarantee a weather-tight enclosure.

Arctic Protection -60°F / -50°C

VIPAK's ABS shell and 1" (25mm) thick wall of urethane insulation combined with O'Brien heaters provide freeze protection at temperatures as low as -60°F / -50°C with a 25mph / 40kph wind.

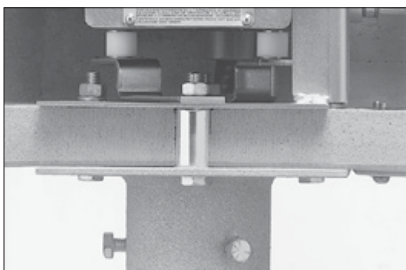

Standard Configuration



TRAKMOUNT™



Heavy Duty SS Hinges & Latches

Custom designed hinges and latches eliminate binding and allow the door or lid to be removed easily.

A Series

Accessible from every angle

- ABS enclosure ideal for pressure, differential pressure and case type instruments in combination with manifolds, air sets, and purge meters.
- Top-hinged for easy access to process instruments from the front, top, or either side.
- Available in three sizes.
- Standard lid-support bracket keeps the lid open.
- Common options include mounting kits, heaters and factory-installed tempered glass windows.



B Series

Front-door access

- ABS enclosure Ideal for case type recorders, indicators, controllers and sample handling or conditioning systems.
- Front door allows easy access to equipment.
- Available in 22 different sizes.
- Common options include mounting kits, rear access panels, surface plates, heaters and factory-installed tempered glass windows.



C Series

Maximum access

- ABS enclosure ideal for pressure, differential pressure and other transmitters in combination with manifolds, air sets, purge meters and output gages.
- Easy-open, tilt-back lid allows access from all sides.
- Available in 25 different sizes.
- Common options include lift access package, parting plates, mounting kits, heater and (W3) windows.



TRAKMOUNT™

Instrument Mounting Made Simple

- Unique track design.
- Instrument brackets can be positioned anywhere in the enclosure.
- Convenience of factory installed brackets.
- Reduced installation time.

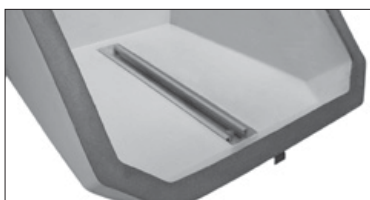

The new Trakmount is recessed in several A and C Series enclosures so the bottom surface is flat. It can be used with any instrument bracket and allows

the transmitter and manifold to be positioned virtually anywhere in the enclosure.



MOUNTING KITS

Mounting kits are easy-to-order combinations of standard mount and bracket components. Refer to pages 17 and 18 for compatibility with enclosure styles and sizes. Mounting kits are used with styles shown in parenthesis behind model numbers.

If you do not find a combination that fits your application, select individual components from the technical specification section on pages 19 thru 21. X designations in the model number are completed by O'Brien at time of order to reflect the exact component needed for the enclosure selected.



- MK1** (A,C)
For back mounting a single transmitter.
- **Universal instrument support bracket**
 - **2" pipe pedestal**



- MK2** (A,C)
For manifold mounting a single transmitter.
- **Universal manifold support bracket**
 - **2" pipe pedestal**



- MK3** (A,C)
For pipe mounting equipment.
- **12" (305mm) tall offset 2" pipe bracket**
 - **2" pipe pedestal**



- MK4** (B)
For pipe mounting equipment.
- **Offset socket bracket for 2" pipe**
 - **Removable 12" (305mm) tall 2" pipe**
 - **2" pipe pedestal**



- MK5X** (B)
Adjustable rails for mounting equipment with a 2" pipe mounting bracket for the enclosure.
- **Adjustable rack bracket**
 - **Vertical 2" pipe mount**



- MK6X** (B)
Adjustable rails for mounting equipment with wall mounting supports for the enclosure.
- **Adjustable rack bracket**
 - **Wall mounting feet**



- MK7** (A,C)
Provides a vertical surface for custom mounting equipment.
- **6" (150mm) wide x 14" (355mm) tall 1/4" (6mm) steel vertical bracket**
 - **2" pipe pedestal**



- MK8** (B)
Adjustable rails on a vertical bracket for mounting equipment.
- **21" (560mm) tall slotted vertical bracket with adjustable rails**
 - **2" pipe pedestal**

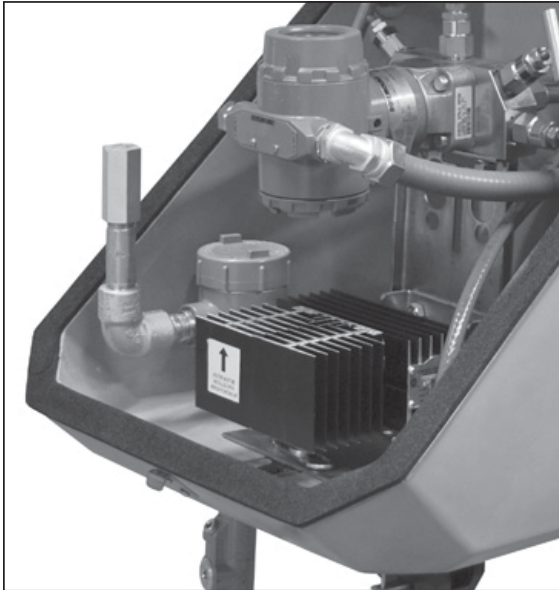

Approvals:

NEC & CSA: Class I, Division 1, Group A, B, C, D
 Class I, Division 2
 ATEX: Zone I EEx d IIC T3

Control Options:

Tamper Proof Thermostat:
 50°F/10°C, 125°F/50°C
 75°F/25°C, 150°F/65°C
 100°F/40°C

For higher temperatures contact your local representative or the factory.

Voltage:

Standard: 115 VAC, 230VAC or 277VAC
 Available: 12 VDC, 24 VDC, 100VAC or 208VAC

Mounting Configuration:

Horizontal or Vertical

Maximum Output Wattage:

	Standard Body	Extended Body
T3 Rating:	200W	400W
T4 Rating:	100W	NA

T-Series heater model number guide and dimensional drawings are available on page 24.

Designed specifically for enclosures

The T-Series heater provides approved hazardous area heaters for a wide range of applications from instrument freeze protection to temperature maintenance for analytical applications. The system is highly configurable and includes redundant internal protection for long trouble free operation.

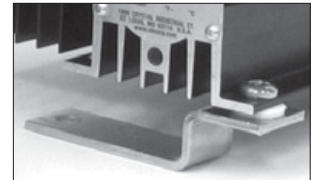

The T-Series heater can be configured for vertical and horizontal installation with maximum efficiency. It is available in two base sizes and variable fin area depending upon wattage and maintain temperature. Our experience with electric heater design and application is reflected in the T-Series heater sizing guide on page 25. Use this chart to confidently select the correct size heater for your installation.

This heater series is available in T3 and T4 temperature ratings to meet the needs of your area classification. It is supplied with a factory set tamper proof temperature switch. The standard junction box volume can be increased to accommodate other wiring connections such as impulse line heater cables.

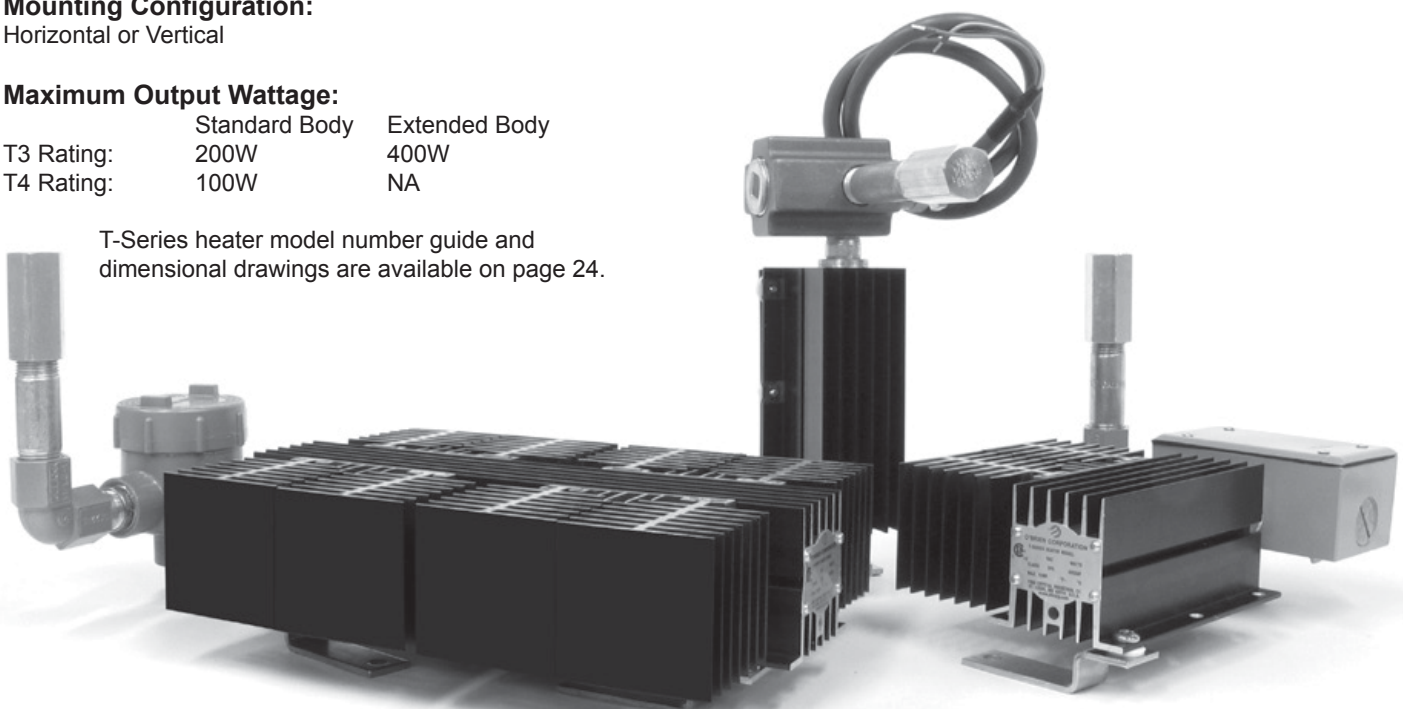

STEAM HEATERS



Six sizes

With a choice of six sizes you can select a steam heater that will provide freeze protection in the winter without overheating the instrument in the summer.

Our experience with steam heater design and application is reflected in the heater sizing guide on page 26. Use this chart to confidently select the right size heater for your installation.

Freeze protection or temperature maintenance

These heaters have been thoroughly tested in our in-house environmental chamber to verify design calculations so that reliable predictions can be made for both low and high ambient conditions.

If you need to maintain precise temperatures you can use the heater control valve (HCV) to control the enclosure temperature. It is available with standard 50°F/10°C and 100°F/40°C set-points. It can also be ordered for special set-point requirements.

Corrosion resistant and efficient

Constructed from stainless steel tubing and carbon steel fins, each unit is coated with a nickel-chrome alloy after assembly. O'Brien steam heaters combine corrosion resistance and heat transfer efficiency in one unit.

Simple connections and installation

Stainless steel mounting hardware is standard with all steam heaters. They fasten the heater to the instrument mounting bracket in the enclosure. The U-bend shape of the heater simplifies connecting the steam supply and condensate return to the $\frac{3}{8}$ " NPT fittings.

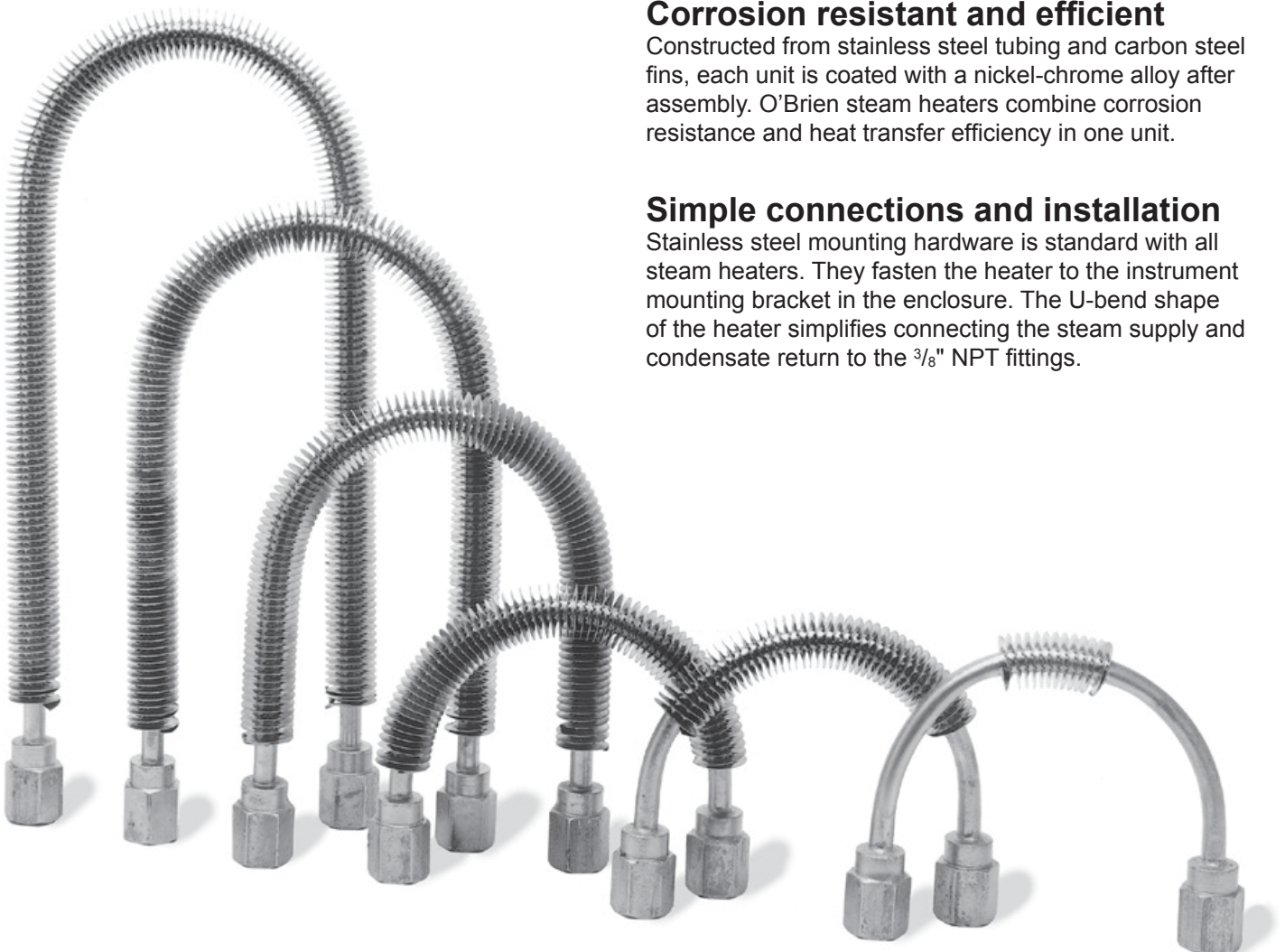



LPD2E shown

LPD2, MLPD2, LPD2E and MLPD2E combination power connection kits

These kits provide a single power connection point for the enclosure heater and TRACEPAK tracer or tracers. They use FM approved and CSA certified Division 2 components and feature an external junction box. (See pg. 21 for complete model number selection.)

IPK1 instrument power and signal connection kit

This option brings instrument power and signal wires to the outside of the enclosure. It includes a 1/2" NPT instrument connection, 24" (600mm) liquid tight flexible metal conduit, and a metallized plate with a 1/2" NPT connection for the outside of the enclosure.

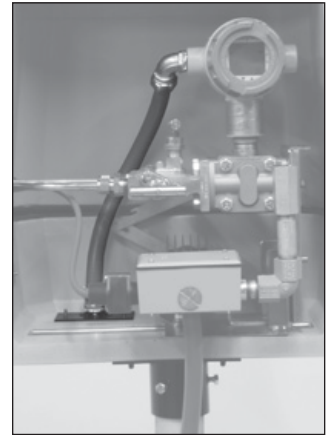

Y and TC power connection kits are electric heater options

For installations that do not require an outside junction box, the Y and TC kit heater options provide an economical and compact power connection for the TRACEPAK tracer.

The Y kit is FM approved and CSA certified for Class I Division 2.

The TC kit (not shown) is CSA certified for Class I Division 1 locations.

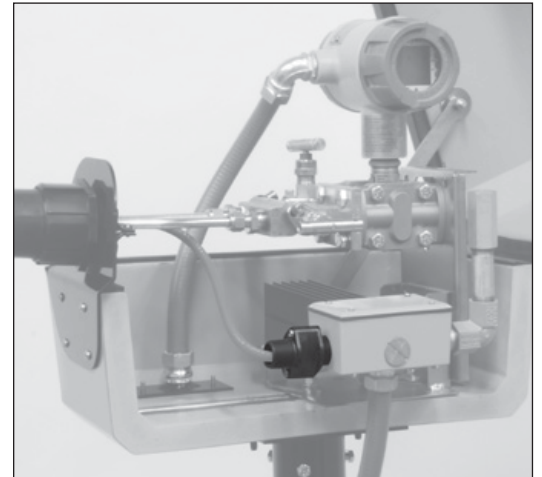

ES heat-shrink entry seals for tubing bundles

These waterproof entry seals have a heat-shrinkable boot at one end and a mounting assembly at the other. They mount directly to the wall of the enclosure or can be supplied with optional plates. The ES fittings will fit TRACEPAK tubing bundles from 3/4" to 3 1/2" (19-90mm) OD.

CONNECTIONS AND OPTIONS

Surface and parting line plates

Parting plates (PP, SPP, DPPT, DSPPT, DSPPT4, DSPPT4S, and DSPPT5) are used with "C" style enclosures to bring process connections through the wall of the enclosure 2" (50mm) above the parting line.

Surface plates (4SP, 4SSP, D4SP, and D4SSP) are used to bring heated connection lines through the wall of the box.

To make your installation job easier, Parting plates and Surface plates can be supplied predrilled to your specifications or split in half.

Tubing and signal lines can be installed directly through the wall of the enclosure by drilling appropriate size holes.

The ABS or GRP shells are strong enough to mount bulkhead fittings directly to the wall of the enclosure. However, you must use plate options when mounting fittings for steam supply or return lines, plate options must be used.

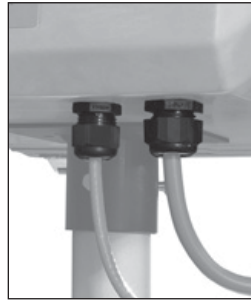

Cord Grips



Bulkhead Fittings



DSPP or DSPPT Parting Plate

Options

Enclosures can be customized for individual applications by adding options:

- Tempered glass windows
- Locking latches
- Drains
- Lid supports
- Access doors
- SS handles
- Blow out discs
- EDPM latches

For an expanded list of mounting hardware, brackets and optional components, refer to pages 19-23.

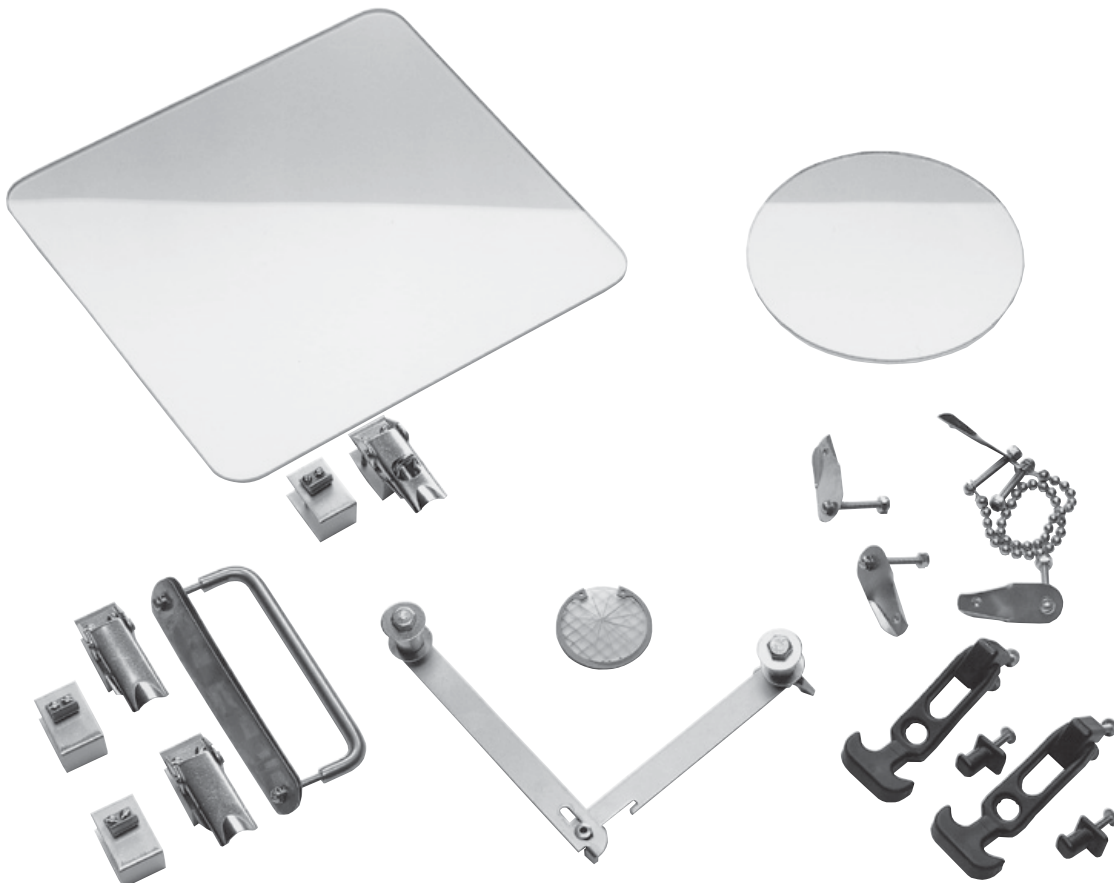

An engineered, pre-traced and pre-insulated tubing bundle system.

More information on preinsulated tubing bundles is available at www.tubingbundle.com and in the O'Brien TRACEPAK Brochure.

TRACEPAK is part of the O'Brien complete instrument winterizing and temperature maintenance solution.

TRACEPAK tubing bundle offers an effective solution to freezing, dew point, component drop out and viscosity control problems in instrument impulse lines, analyzer sample transport lines and small diameter process lines.

Typical Applications:

- **IMPULSE LINES** for flow, pressure, level transmitters, pressure switches, controllers.
- **SAMPLE LINES** for process and emissions analyzers, chromatographs.
- **PROCESS LINES**, steam supply, condensate return, water purge, chemical feed, instrument air lines.

Choose electric traced lines, steam traced lines with heavy or light tracing, or a single pre-insulated line for steam supply and condensate return.

The economical alternative to field fabrication

- Maintenance free.
- Save time during engineering and design.
- Ensures consistent, repeatable performance.
- FEA (finite element analysis) verified designs.

Parallel configuration makes field installation easy

- Bending radius as short as 8" (200mm).
- Easy installation of process and instrument connections.
- Tubes will stay round and ready to be fitted in a compression type fitting.
- One pass, one craft installation.

Sample transport bundles for analyzer applications

- Factory installed sensors for precise temperature control.
- Wide range of common and specialty tube materials and sizes:
 - Welded and seamless SS
 - Hastelloy®
 - Super-Duplex
 - Teflon®
 - Incoloy®
 - Silica lined
- TrueTube® improved sample transport tubes from O'Brien that reduce or eliminate the problems of long dry-down times and adsorption / desorption.

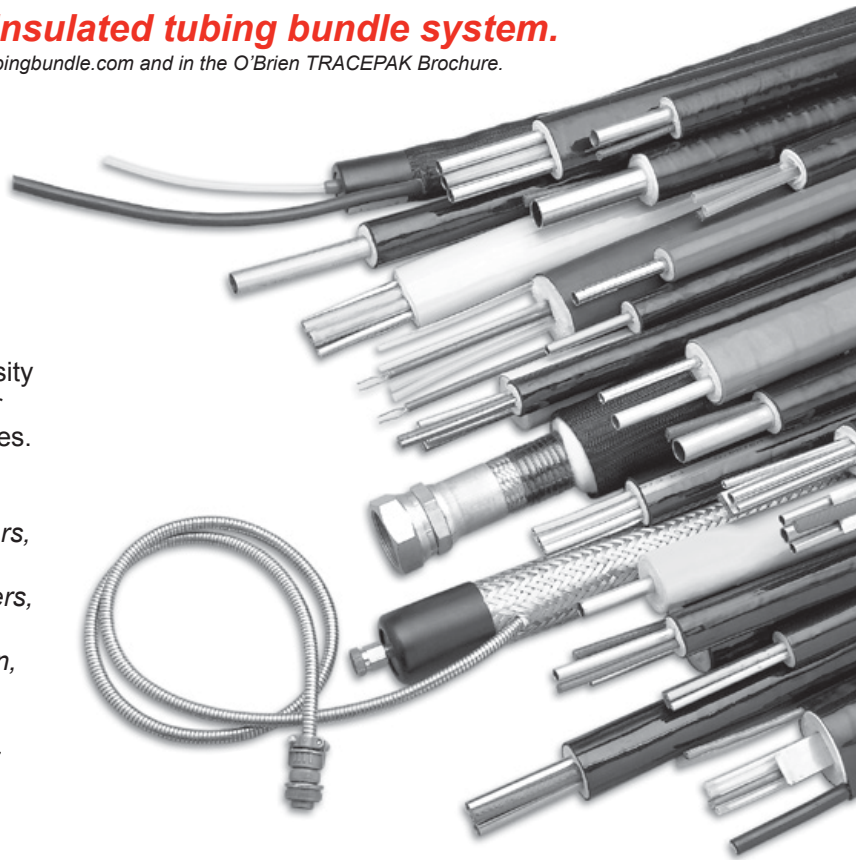

Anywhere small diameter tubing is used and you need to provide insulation, freeze protection or temperature maintenance, a manufactured tubing bundle will save time and money as well as reducing maintenance costs and improving performance.

Standard materials reduce sources for chloride stress corrosion of stainless steel tubes

- Low chloride insulation.
- Two jacket materials:
 - TPU - contains no chlorides, eliminates possibility of jacket causing stress corrosion.
 - SV47 - low temperature polyvinyl chloride for economical weather barrier.

Designed for your application

- Temperature maintenance up to 650°F / 340°C.
- Withstand a high temperature blowdown of 1100°F / 600°C.
- Freeze protection designs do not require expensive temperature controllers.
- Factory installed temperature sensors.
- Multiple tubes for process lines and calibration gas.
- Communication wires and power wiring, steam or electric tracing.

Hastelloy® is a registered trademark of Haynes International.
Incoloy® is a registered trademark of INCO Alloys International, INC.
Teflon® is a registered trademark of IE DuPont DeNemors Corporation.

APPLICATIONS

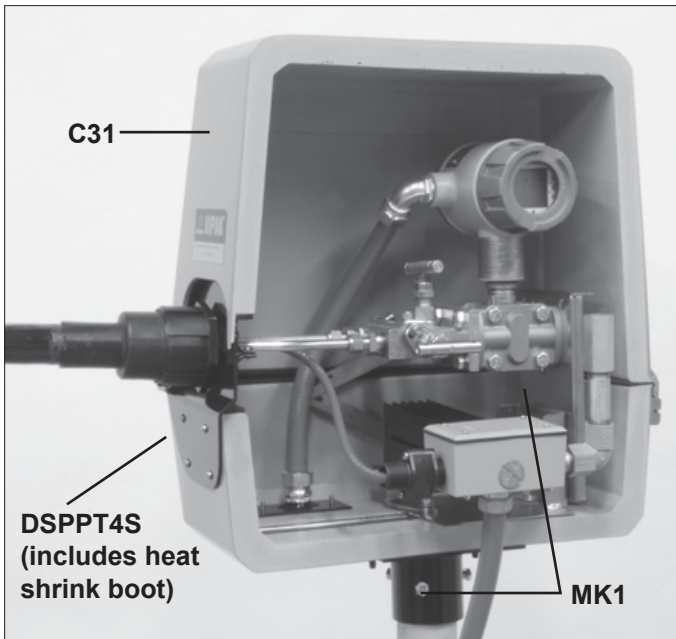

This enclosure shows a single back mounted instrument.



The C31 is a typical enclosure for a single instrument.

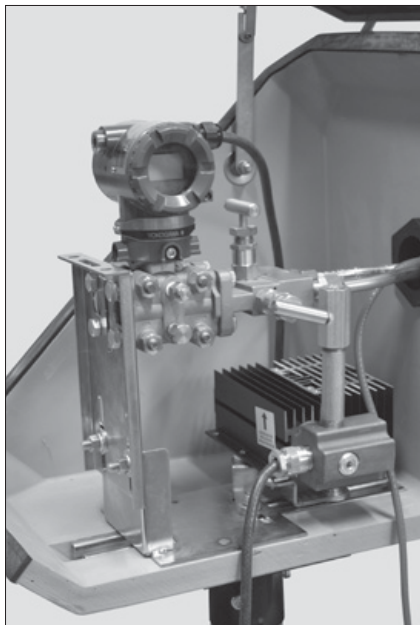

Instrument mounted application with ATEX approved heater.

Even a single instrument enclosure can be fitted out with a variety of options. This enclosure shows a manifold mounted instrument with the LPD2E power connection kit for TRACEPAK tubing bundles, the IPK1 instrument connection kit and an ES4S heat shrink entry seal boot.

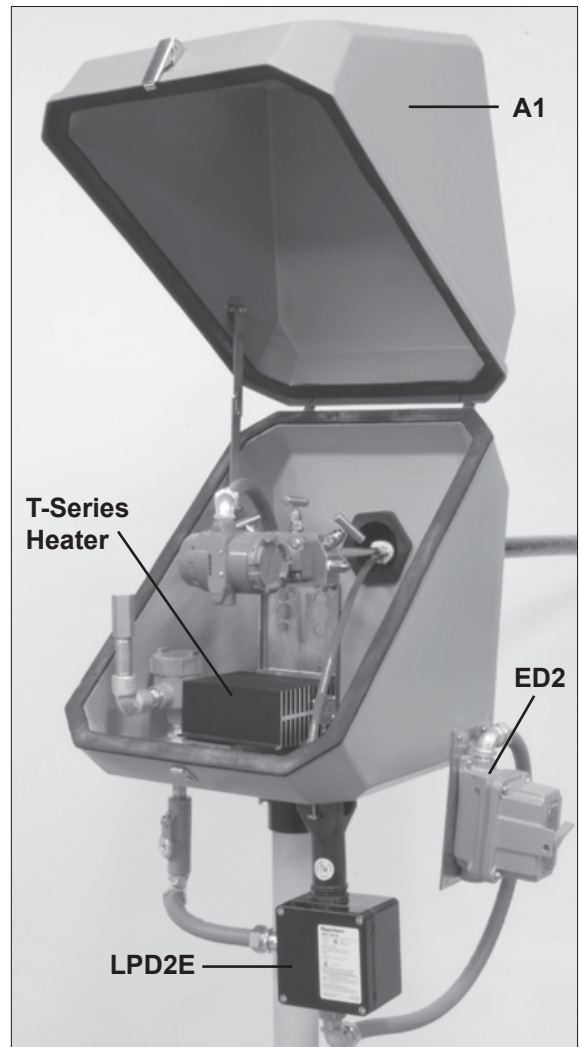



“A” Series enclosures have 3 sizes to accommodate single and multi-instrument applications.

A B3 enclosure fitted with adjustable mounting rails will accommodate most case style instruments. Bulkhead fittings can be mounted directly to the enclosure wall.

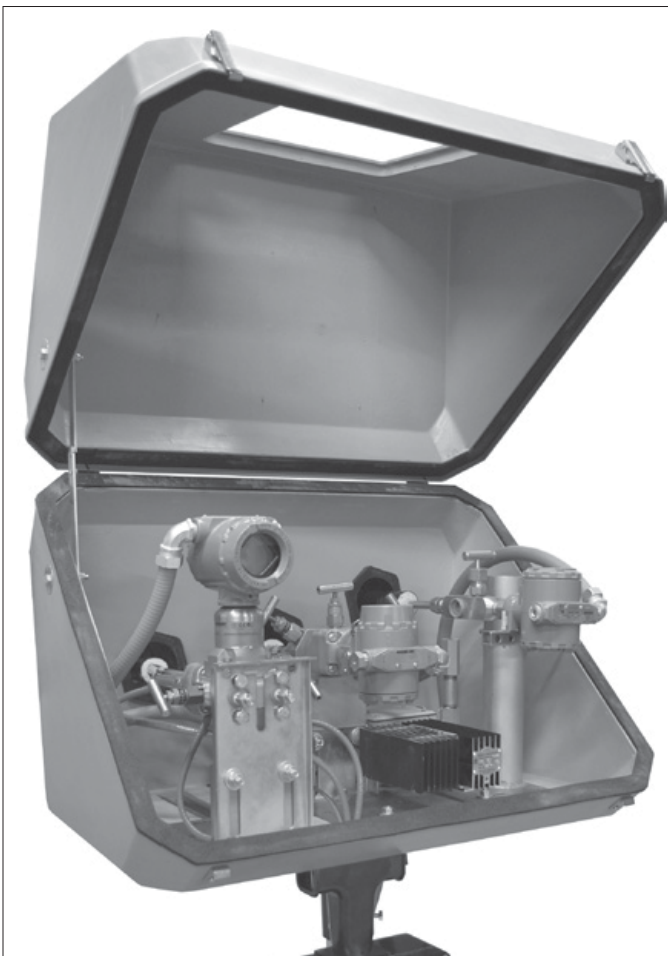
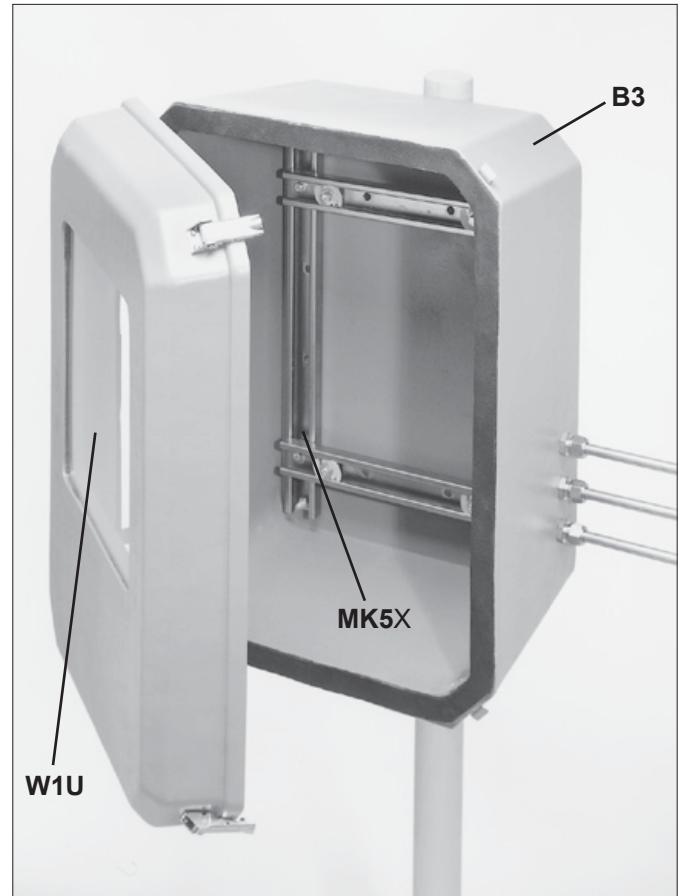

Model A3 enclosures accommodate triple instrument requirements.

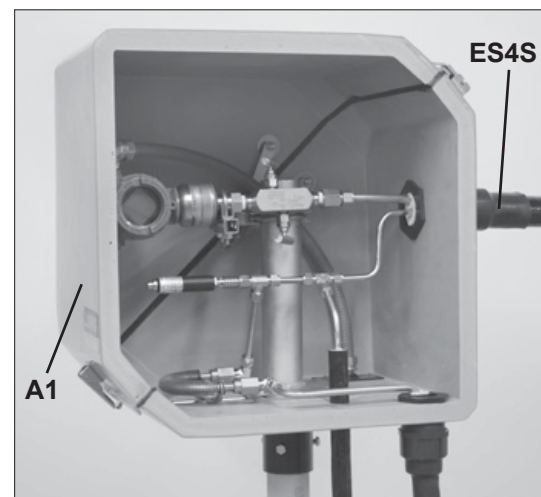

The A1 enclosure is ideal for a single instrument installation. Process piping can exit the back wall or bottom of the enclosure.

SUNSHADE

Maintains process accuracy by shielding instrumentation from solar heat

Four sizes - SUNSHADE provides protection for single or multiple instruments, preventing instrument calibration drift due to temperature changes caused by solar radiation.

Mechanical protection - SUNSHADE will shield instruments from the sun and provide partial protection from falling objects, rain, snow, and wind blown sand.

UV and corrosion resistant - The blended ABS material has excellent UV and corrosion resistance.

Easy access to instruments - SUNSHADE mounts to a standard 2" pipe stand and can be removed easily for full instrument access.

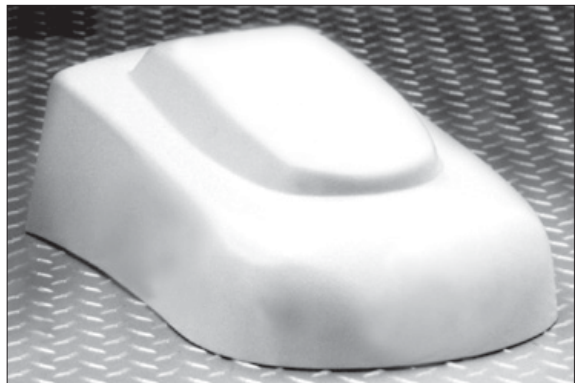
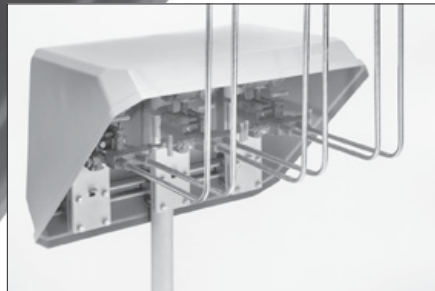

E4 SUNSHADE

The E4 SUNSHADE features a design that is stackable to minimize shipping costs, lightweight, impact resistant, and UV resistant.

E1B SUNSHADE

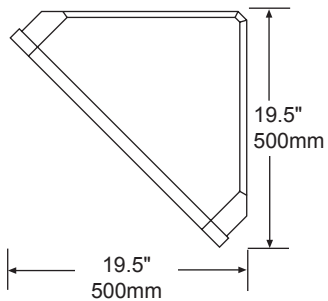
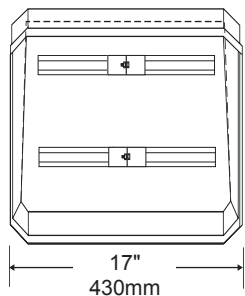

E4B SUNSHADE

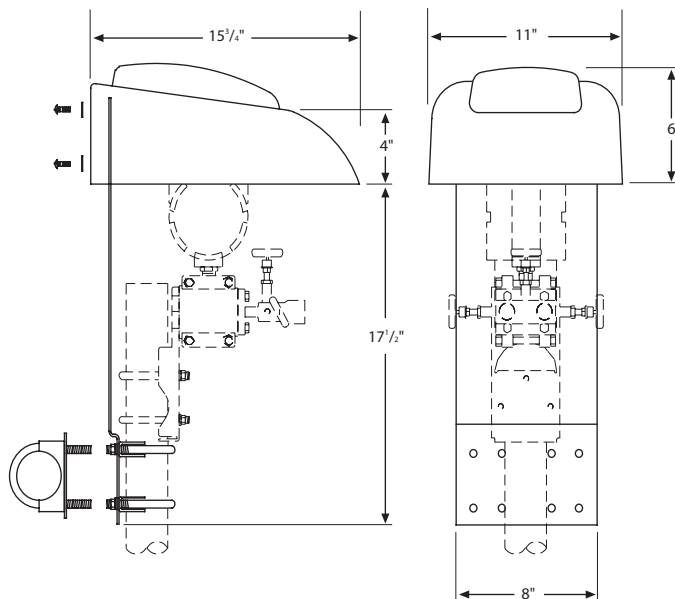

E2B SUNSHADE

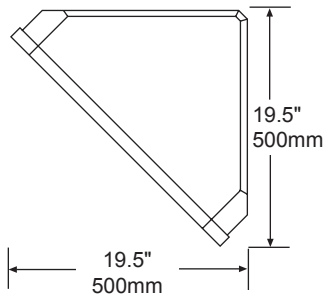
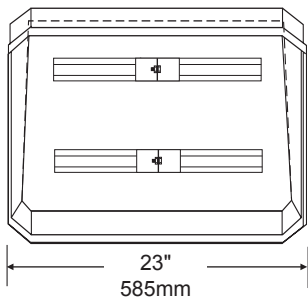

E3B SUNSHADE

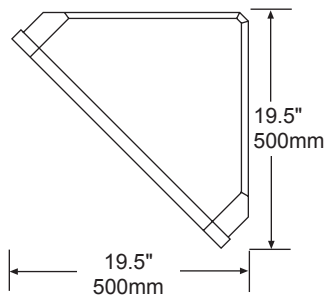
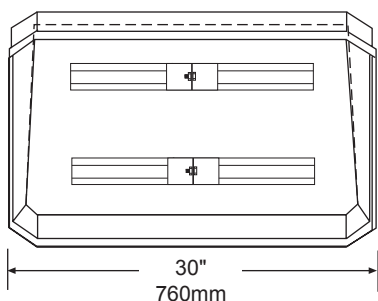

Select the SUNSHADE size required: E1B, E2B, E3B, or E4B.

Select the SADDLEPAK® support required, refer to SADDLEPAK brochure for complete details.

VIPAK HOW TO ORDER

- 1 Select an enclosure style and size.....(pg. 17)
- 2 Add a mounting kit or combine a mount and bracket.....(pgs. 17, 19-21)
- 3 Add an electric or steam heater.....(pgs. 18, 24-26)
- 4 Add entry fittings, plates, connections and other options to complete the package.....(pgs. 18, 21-23)
- 5 Select TRACEPAK® pre-insulated tubing bundle configuration.....(Consult TRACEPAK brochure or website www.obcorp.com)

A Series

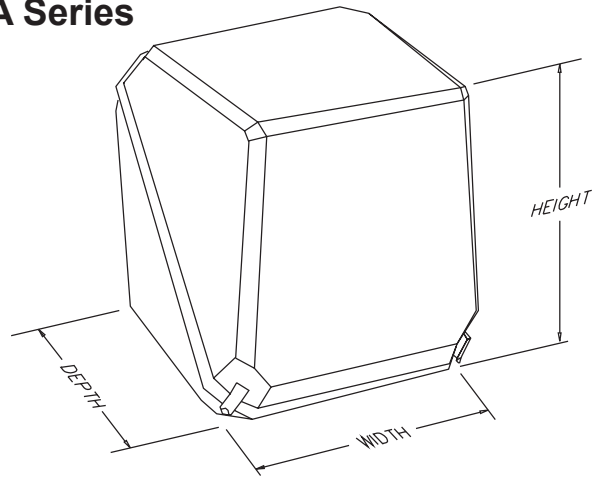

Description	Model #
C Style VIPAK enclosure for a single flow transmitter and manifold 11"(280mm)W x 16" (405mm) D x 17"(430mm)H	C31
Manifold mounted instrument and enclosure mounted on 2" pipe stand	MK2
Electric heat to maintain 50°F/10°C on a -20°F/-30°C day (wattage selected from sizing chart on page 25) heater approved for Class 1, Div. 2 hazardous areas, 115 VAC	TS3110D2 CJS9H
Combination power connection kit for enclosure heater and TRACEPAK tubing bundle (see pg. 21 for selection)	LPD2
Heat-shrink entry seal for TRACEPAK tubing bundle 1.7" x 1.4" (45mm x 35mm)	ES4S
Parting plate for process connections drilled for ES4S	DPPT
Completed VIPAK model #: C31-MK2-TS3110D2CJS9-LPD2-ES4S-DPPT	

B Series

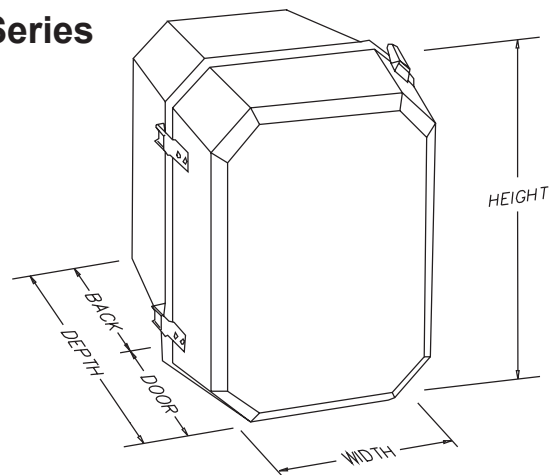

C Series

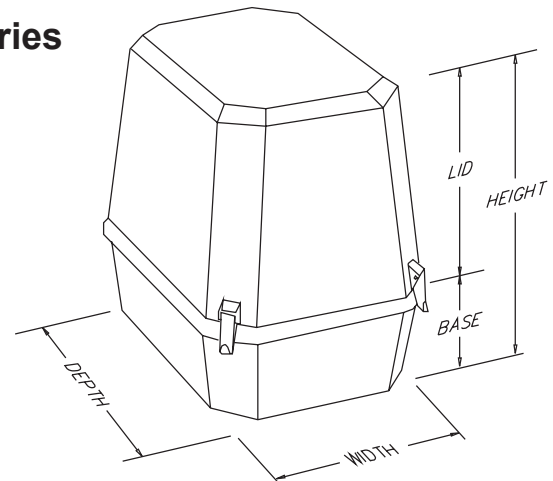

COMPONENT COMPATIBILITY GUIDE

This selection chart indicates common choices
 Some choices may require nonstandard configurations and should be confirmed by the factory.
 Not all possible combinations are listed. Consult the factory if the combination you need is not listed.

All values are inside dimensions at the parting line of the enclosure. Add for 1" (25mm) wall thickness.

Width" (mm)		Height" (mm)		Depth" (mm)		Door/Back" (mm)		Enclosure Model		Mounting Kits		Mounts		Brackets													
Width	Depth	Height	Base/Lid	Width	Depth	Height	Base/Lid	Model	T	T2	T3	LA	E	A	UB	MSB	IPBXXX**	IPBOXXX**	X RPBO**	FPB	14X VB**	21SVB	RBX**	22PB	HB		
15 (380)	18.5 (470)	18.5 (470)							*A1																		
21 (530)	18.5 (470)	18.5 (470)							*A2																		
28 (710)	18.5 (470)	18.5 (470)							*A3																		
11 (280)	16 (405)	10 (250)	5/5 (125/125)						B32																		
11 (280)	16 (405)	17 (430)	5/12 (125/305)						B31																		
11 (280)	16 (405)	24 (610)	12/12 (305/305)						B33																		
16 (405)	11 (280)	10 (250)	5/5 (125/125)						B232																		
16 (405)	11 (280)	17 (430)	5/12 (125/305)						B231																		
16 (405)	11 (280)	24 (610)	12/12 (305/305)						B233																		
16 (405)	16 (405)	10 (250)	5/5 (125/125)						B6																		
16 (405)	16 (405)	19 (480)	5/14 (125/355)						B5																		
16 (405)	16 (405)	28 (710)	14/14 (355/355)						B7																		
16 (405)	22.5 (570)	10 (250)	5/5 (125/125)						B15																		
16 (405)	22.5 (570)	14 (355)	2/12 (50/305)						B3																		
16 (405)	22.5 (570)	17 (430)	5/12 (125/305)						B14																		
16 (405)	22.5 (570)	24 (610)	12/12 (305/305)						B4																		
16 (405)	22.5 (570)	7 (180)	2/5 (50/125)						B22																		
22.5 (570)	16 (405)	10 (250)	5/5 (125/125)						B215																		
22.5 (570)	16 (405)	14 (355)	2/12 (50/305)						B203																		
22.5 (570)	16 (405)	17 (430)	5/12 (125/305)						B214																		
22.5 (570)	16 (405)	24 (610)	12/12 (305/305)						B204																		
22.5 (570)	16 (405)	7 (180)	2/5 (50/125)						B222																		
24 (610)	32 (810)	17 (430)	5/12 (125/305)						B48																		
24 (610)	32 (810)	10 (250)	5/5 (125/125)						B49																		
24 (610)	32 (810)	24 (610)	12/12 (305/305)						B50																		
11 (280)	16 (405)	10 (250)	5/5 (125/125)						C32																		
11 (280)	16 (405)	17 (430)	5/12 (125/305)						C31																		
11 (280)	16 (405)	24 (610)	12/12 (305/305)						C33																		
16 (405)	11 (280)	10 (250)	5/5 (125/125)						C232																		
16 (405)	11 (280)	17 (430)	5/12 (125/305)						C231																		
16 (405)	11 (280)	24 (610)	12/12 (305/305)						C233																		
16 (405)	16 (405)	10 (250)	5/5 (125/125)						C6																		
16 (405)	16 (405)	19 (480)	5/14 (125/355)						C5																		
16 (405)	16 (405)	28 (710)	14/14 (355/355)						C7																		
16 (405)	22.5 (570)	10 (250)	5/5 (125/125)						C15																		
16 (405)	22.5 (570)	14 (355)	2/12 (50/305)						C3																		
16 (405)	22.5 (570)	17 (430)	5/12 (125/305)						C14																		
16 (405)	22.5 (570)	24 (610)	12/12 (305/305)						C4																		
16 (405)	22.5 (570)	7 (180)	2/5 (50/125)						C22																		
22.5 (570)	16 (405)	10 (250)	5/5 (125/125)						C215																		
22.5 (570)	16 (405)	14 (355)	2/12 (50/305)						C203																		
22.5 (570)	16 (405)	17 (430)	5/12 (125/305)						C214																		
22.5 (570)	16 (405)	24 (610)	12/12 (305/305)						C204																		
22.5 (570)	16 (405)	7 (180)	2/5 (50/125)						C222																		
24 (610)	32 (810)	17 (430)	5/12 (125/305)						*C48																		
24 (610)	32 (810)	10 (250)	5/5 (125/125)						*C49																		
24 (610)	32 (810)	24 (610)	12/12 (305/305)						*C50																		
32 (810)	24 (610)	17 (430)	5/12 (125/305)						*C248																		
32 (810)	24 (610)	10 (250)	5/5 (125/125)						*C249																		
32 (810)	24 (610)	24 (610)	12/12 (305/305)						*C250																		

B - Mounts to bottom of enclosure only.
 * Included lid support (LS) as standard.
 Specifications and available options are subject to change without notice.

Component Compatibility Guide continues on page 18.

COMPONENT COMPATIBILITY GUIDE (continued)

Enclosure Model
To specify anti-static option replace 'E' with 'A' in enclosure model number.

Electric Heaters - Select from pages 24-25

	T Style		Connections		Steam Heaters		Bundle Entry Fittings		Parting Plates		Surface Plates		Windows		Other Options														
	T	Y	LPD2 / MLPD2 (combination power connection kit)	IPK1 (instrument connection kit)	OJ (outside junction box)	ED, EDBC, ED2, EDE1 (electrical disconnect)	ES4 (0.75" - 1.6" / 20-40mm dia. tubing bundle fitting)	ES5	ES6X	PP (parting line plate)	SPP (split parting line plate)	DPPT (parting line plate for fitting)	DSPTT (split parting line plate for TRACEPAK)	4SP (4" x 6" / 100mm x 150mm surface plate)	4SPP (split surface plate)	W1 (12"x12" / 305mm x 305mm)	W3 (7" / 180mm dia.)	PH (non-metallic hardware, lift access only)	DA (access door)	R (door/lid retainer)	LS (lid/door support)	H (handle)	BO (blow-out disk)	D (drain plug)	SK (RTV sealant)	LL (locking latch)	PT (phonetic tag)		
*A1	•	•	•	•	•	•	•	•	•																				
*A2	•	•	•	•	•	•	•	•	•																				
*A3	•	•	•	•	•	•	•	•	•																				
B32	•	•	•	•	•	•	•	•	•																				
B31	•	•	•	•	•	•	•	•	•																				
B33	•	•	•	•	•	•	•	•	•																				
B232	•	•	•	•	•	•	•	•	•																				
B231	•	•	•	•	•	•	•	•	•																				
B233	•	•	•	•	•	•	•	•	•																				
B6	•	•	•	•	•	•	•	•	•																				
B5	•	•	•	•	•	•	•	•	•																				
B7	•	•	•	•	•	•	•	•	•																				
B15	•	•	•	•	•	•	•	•	•																				
B3	•	•	•	•	•	•	•	•	•																				
B14	•	•	•	•	•	•	•	•	•																				
B4	•	•	•	•	•	•	•	•	•																				
B22	•	•	•	•	•	•	•	•	•																				
B215	•	•	•	•	•	•	•	•	•																				
B203	•	•	•	•	•	•	•	•	•																				
B214	•	•	•	•	•	•	•	•	•																				
B204	•	•	•	•	•	•	•	•	•																				
B222	•	•	•	•	•	•	•	•	•																				
B48	•	•	•	•	•	•	•	•	•																				
B49	•	•	•	•	•	•	•	•	•																				
B50	•	•	•	•	•	•	•	•	•																				
C32	•	•	•	•	•	•	•	•	•																				
C31	•	•	•	•	•	•	•	•	•																				
C33	•	•	•	•	•	•	•	•	•																				
C232	•	•	•	•	•	•	•	•	•																				
C231	•	•	•	•	•	•	•	•	•																				
C233	•	•	•	•	•	•	•	•	•																				
C6	•	•	•	•	•	•	•	•	•																				
C5	•	•	•	•	•	•	•	•	•																				
C7	•	•	•	•	•	•	•	•	•																				
C15	•	•	•	•	•	•	•	•	•																				
C3	•	•	•	•	•	•	•	•	•																				
C14	•	•	•	•	•	•	•	•	•																				
C4	•	•	•	•	•	•	•	•	•																				
C22	•	•	•	•	•	•	•	•	•																				
C215	•	•	•	•	•	•	•	•	•																				
C203	•	•	•	•	•	•	•	•	•																				
C214	•	•	•	•	•	•	•	•	•																				
C204	•	•	•	•	•	•	•	•	•																				
C222	•	•	•	•	•	•	•	•	•																				
*C48	•	•	•	•	•	•	•	•	•																				
*C49	•	•	•	•	•	•	•	•	•																				
*C50	•	•	•	•	•	•	•	•	•																				
*C248	•	•	•	•	•	•	•	•	•																				
*C249	•	•	•	•	•	•	•	•	•																				
*C250	•	•	•	•	•	•	•	•	•																				

** - These items are sized by O'Brien depending upon enclosure and other options selected.
 B - Mounts to bottom of enclosure only.
 Zinc metallizing available - consult factory.
 Specifications and available options are subject to change without notice.

Finish: All mounting kits have a durable industrial grade finish.
X designations in the model number are completed by O'Brien at time of order.

Factory Installation: These options are not normally factory installed unless specifically noted or with TRAKMOUNT option. To designate factory installation, add "-F" to the end of the model number (e.g. **MK1-F**) and note instrumentation to enclose, or specify location (See page 27).

MK1

For back mounting a single transmitter in an A or C style enclosure.
Includes: 1-**UB** and 1-**FM**.

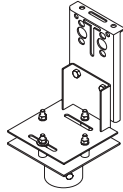

MK2

For manifold mounting a single transmitter in an A or C style enclosure.
Includes: 1-**MSB** and 1-**FM**.

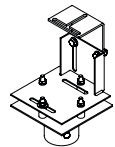

MK3

For pipe mounted equipment in an A or C style enclosure.
Includes: 1-**IPBOF12** and 1-**FM**.



MK4

For pipe mounted equipment in a B style enclosure.
Includes: 1-**RPBO12** and 1-**SM**.

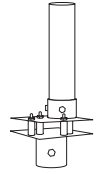

MK5X

For mounting equipment to an adjustable rack inside a 2" pipe mounted B style enclosure.
Includes: 1-**RBX** and 1-**2VPMXX**.

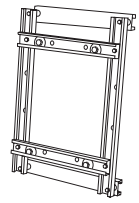

MK6X

For mounting equipment to an adjustable rack inside a wall mounted B style enclosure.
Includes: 1-**RBX** and 1-**PMB**.

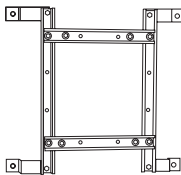

MK7

For custom mounting equipment in an A or C style enclosure.
Includes: 1-**14FVB** and 1-**FM**.

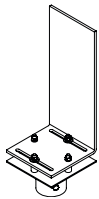

MK8

Adjustable rails for mounting equipment in a B style enclosure.
Includes: 1-**21SVB** and 1-**SM**.

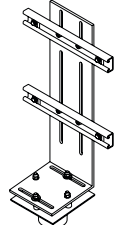

UMBX (Universal Mounting Bracket)

For back mounting a transmitter in smaller C style enclosures. Combines the instrument mounting hole pattern from the UB with a universal 2" pipe mounting bracket for vertical or horizontal pipe. Factory installed centered on back of enclosure.

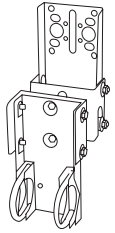

OMB (On Line Mounting Bracket)

For mounting A, B, or C style enclosures around in-line instruments. Individual mounting brackets are required for each side of the enclosure. Factory installed, specify location (page 27) and pipe size from 3/4" to 4" as prefix. (e.g. **1.50MB** for 1.5" pipe)

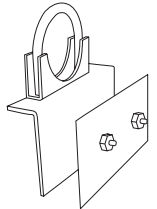

FMB (Flange Mounting Bracket)

This bracket mounts C style enclosures to the process flanges of the instrument and vessel. Factory installed centered on the front of the enclosure. Add flange size **2, 3, or 4"** and rating **150# or 300#** to the end of the component model number. (e.g. **FMB23** for 2" 300# flange)

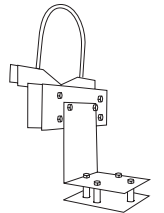

PMB (Panel Mounting Bracket)

For wall mounting B style enclosures, it provides mounting studs inside the enclosure for optional or customer supplied panels.

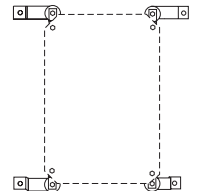

MOUNTS

Combine with brackets selection to complete thru-bolt support.

Finish: All mounts have a durable industrial grade finish. X designations in the model number are completed by

O'Brien at time of order.

FM (Flat Mount)

2" pipe pedestal for A and C style enclosures. Includes three set screws to securely fasten the enclosure to the pipe stand.

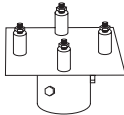

SM (Slant Mount)

2" pipe pedestal for B style enclosures. Includes three set screws to securely fasten the enclosure to the pipe stand.

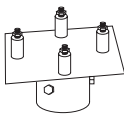

LFM (Large Flat Mount)

2" pipe pedestal for large A and C style enclosures (see page 17). Includes three set screws to securely fasten the enclosure to the pipe stand.

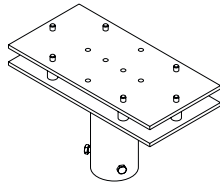

LSM (Large Slant Mount)

2" pipe pedestal for large B style enclosures (see page 17). Includes three set screws to securely fasten the enclosure to the pipe stand.

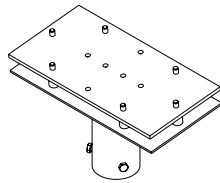

FPM (Flat Plate Mount)

10 ga. flat plate used to complete the mounting of an instrument bracket when no other external mount is specified.

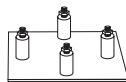

D7FM (Dual Flat Mount)

A 6" (150mm) deep 2" pipe pedestal designed to support two interior brackets on 7" (178mm) centers. (A & C styles only)

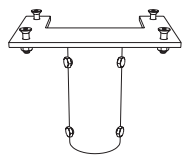

T7FM (Triple Flat Mount)

A 6" (150mm) deep 2" pipe pedestal designed to support three interior brackets on 7" (178mm) centers. (A & C styles only)

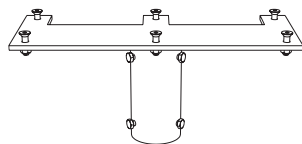

WM (Wall Mount)

Two angled plates bolt a B style enclosure against a wall or to a 2" vertical pipe with customer supplied U-Bolts.

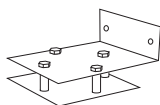

2VPMXX (Vertical Pipe Mount)

This allows B style enclosures to be mounted to a 2" vertical pipe. Use with "RBX".

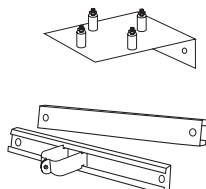

BRACKETS

Finish: All brackets have a durable industrial grade finish.

Factory Installation: These options are not normally factory installed. To designate factory installation, add the suffix "-F" to the end of the bracket model number (e.g. **MSB-F**) and note instrumentation to enclose, or specify location (see pg. 27). The mount and heater included with the enclosure will also be installed.

X designations in the model number are completed by

O'Brien at time of order.

UB (Universal Bracket)

The universal bracket includes mounting holes for most transmitters replacing the bracket supplied with the instrument. It positions the process connections to line up with Parting Plates when used in C style enclosures with a 5" (125mm) deep base. The instrument mounting height is adjustable to maintain the proper impulse line slope for gas or liquid service. Used in A or C style enclosures.

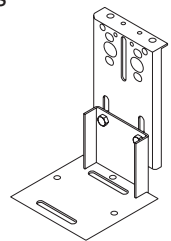

MSB (Manifold Support Bracket)

The universal manifold mount bracket will directly replace most optional mounting brackets from the manifold manufacturer. It positions the process connections to line up with Parting Plates when used in C style enclosures with a 5" (125mm) deep base. The instrument height is adjustable to maintain the proper impulse line slope for gas or liquid service. Used in A or C enclosures.

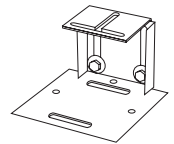

CSB (Coplanar Support Bracket)

Designed for use with Rosemount coplanar style instruments. It replaces most optional mounting brackets from the instrument manufacturer. The height is variable and it can position the process connections to line up with Parting Plates when used in C style enclosures with a 5" (125mm) deep base.

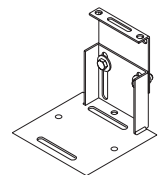

IPBXXX (Internal Pipe Bracket)

2" instrument mounting pipe. The height is either 6" (150mm), 12" (305mm) or 18" (455mm) depending upon the enclosure size and style. Available for A, B, or C style enclosures.

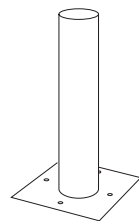

IPBOXXX (Internal Pipe Bracket Offset)

2" instrument mounting pipe offset on the base so that the pipe can be positioned closer to the wall of the enclosure. The height is either 12" (305mm) or 18" (455mm) depending upon the enclosure size and style. Available for A, B, or C style enclosures.

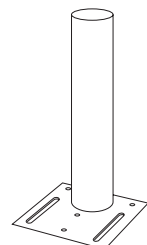

XRPBO (Removable Pipe Bracket Offset)

Used to support customer supplied pipe. The 2" deep socket is offset to the edge of the base for more flexibility in positioning the instrument. Available for A, B, or C style enclosures.

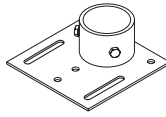

FPB (Flat Plate Bracket)

10 ga. flat plate used to complete installation of an external mount when no other instrument bracket is ordered.



14XVB (Vertical Bracket)

A 6" (150mm) wide by 14" (355mm) tall 1/4" (6mm) thick vertical bracket. Available for A, B, or C style enclosures.



21SVB (Vertical Bracket)

A 21" (530mm) tall 1/4" (6mm) thick vertical bracket with 14" (355mm) wide adjustable rail cross arms. Used in B style enclosures.

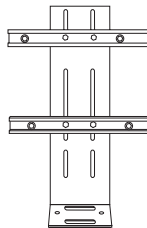

RBX (Rail Bracket)

Two vertical rails are mounted to the back of B style enclosures. Two adjustable horizontal rails can be positioned to mount almost any instrument. Must use with "2VPMXX" or "PMB" mounts to support the enclosure.

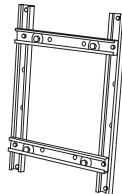

22PB (Panel Bracket)

A 14 1/4" (360mm) wide x 22" (560mm) tall 12 ga. plate bracket with supports. Factory installed in B style enclosures.

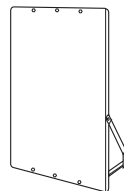

HB (Heater Bracket)

A 3" x 6" (360mm x 150mm) 10 ga. heater bracket provides a mounting surface for electric or steam heaters when no other bracket is used.

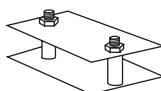

Factory Installation: Consult factory for explanation.

LPD2/MLPD2

Provides a single power connection point for enclosure heater and TRACEPAK tracers.

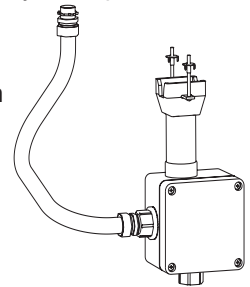

Electric Heater Series	One Tracer	Three Tracers
DIV 1	LPD2E	MLPD2E
DIV 2	LPD2	MLPD2

IPK1 (Instrument Power Kit)

Brings instrument power and signal wires to the outside of the enclosure. Class I Division 2, Group A,B,C,D components.

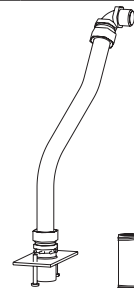

OJ (Outside Junction)

The "OJ" option provides an outside junction box for electric heaters. Class I Division 2, Group A,B,C,D components.

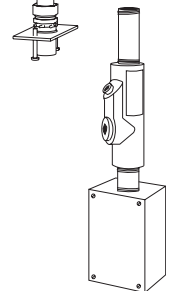

Y (Heater Option)

The "Y" heater power connection kit option is FM approved for Cl. I, Div. 2 areas when used to connect TRACEPAK XTV and BTV tracers. It is supplied, installed on the heater junction box.

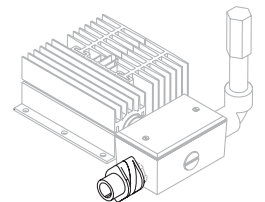

TC (Heater Option)

The "TC" heater power connection kit option is CSA Certified for Cl. I, Div. 1 areas when used to connect TRACEPAK XTV and BTV tracers. It is supplied installed on the heater junction box.

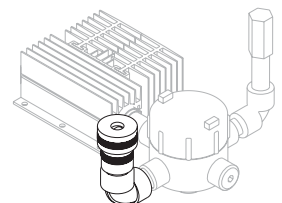

ED, EDBC, ED2, EDE1

(Electrical Disconnect)
External electrical disconnect switch complete with junction box, FM approved and CSA certified for:
ED: Cl. I, Div. 1, Groups C&D.
EDBC: Cl. I, Div. 1, Groups B,C&D.
ED2: Cl. I, Div. 2, Groups C&D.
EDE1: EEx cd IIC T6

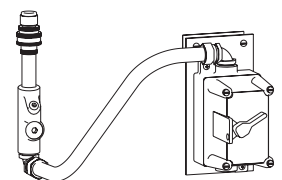

(ED shown)

ENTRY PLATES

Finish: All plates have a durable industrial grade finish.
Factory Installation: Parting plates are factory installed centered on the front of C style enclosures. Surface plates are not installed. To designate factory installation, add “-I” to the end of the model number (e.g. **4SP-I**) and specify location (See page 27).

Adding Holes to Plates: Plates can be customized with factory drilled holes. Add “D” to beginning of component model number (e.g. **DSPP**). Specify size and location. If holes are to accommodate TRACEPAK tubing bundles, add “T” to the end of the component model number, and specify TRACEPAK model number instead of hole size (e.g. **DSPP-T**).

ES4, ES4S, ES5, ES6X (Entry Seal)

This heat-shrinkable entry seal provides a waterproof fitting where TRACEPAK enters an enclosure. Available in three sizes it has an O-ring and threaded jam nut for a superior seal.

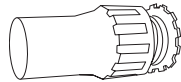

Model	Panel Thickness (in/mm)		Mounting Hole Dia.	Bundle Size	
	Min	Max		Min	Max
ES4	0.93 / 24	1.6 / 40	2 / 50	0.75 / 20	1.6 / 40
ES4S	0.6 / 15	1.6 / 40	2-3/8 / 60	0.75 / 20	2.1 / 54
ES5	0.91 / 23	1.95 / 50	3-3/8 / 85	1.43 / 36	2.75 / 70
ES6X	0.0 / 0	2.2 / 56	4.5 / 114	1.5	3.7

4SP (Surface Plate)

This 4" x 6" (100mm x 150mm) surface plate is designed to be mounted on the stationary portion of the enclosure.



4SSP (Split Surface Plate)

This 4" x 6" (100mm x 150mm) split surface plate is designed to be mounted on the stationary portion of the enclosure.



PP (Parting Plate)

The parting plate is a one-piece plate factory mounted at the parting line on the front center of C style enclosures.

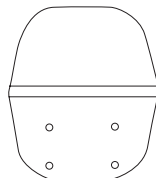

SPP and DSPP (Split Parting Plate)

This factory mounted plate is the same as the PP except it is split and has a preformed opening to accept 1/2" pipe on 2 1/8" (54mm) centers.

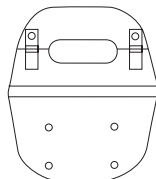

DSPPT (Drilled Split Parting Plate)

This factory mounted split parting plate is the same as the PP except it is factory drilled for TRACEPAK tubing bundle.

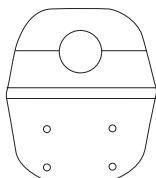

WINDOWS

Mounting Locations: Windows are factory installed, specify location to center of window (Refer to page 27) or note instrument to enclose. On B style enclosures windows can be located in the upper 1/3, center, or lower 1/3 of the door by adding “U”, “C”, or “L” to the end of the window model number. (e.g. **W1C**)

W1 (Window)

The “W1” is a 1/4" (6mm) thick, 12" x 12" (305mm x 305mm) tempered glass window to provide a large viewing area.

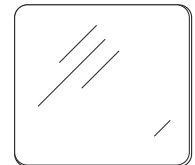

W3 (Window)

The “W3” is a 1/4" (6mm) thick, 7" (180mm) round tempered glass window allows select viewing of instrumentation.

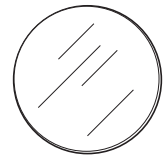

LA (Lift Access)

Replaces hinges with latches so lid or door is lifted off instead of hinged. Also adds a stainless steel handle to the center of the lid or door. (On size 48, 49, 50, 248, 249, and 250 enclosures two handles are provided.) To specify, add to enclosure model # e.g. "C31LA".

PH (Plastic Hardware)

EDPM latches replace standard stainless steel latches and hinges. Provided as lift access only, do not also specify "LA" option.

DA (Door Access)

Provides a removable access panel in the back of larger B style enclosures designed to make installation of back connected instruments easier. It is attached to the enclosure and includes a stainless steel handle.

R (Retainer)

Door or lid retainer. Permanently attaches the lid or door to the base of the enclosure to keep them from being misplaced when they are removed.

LS (Lid Support)

Lid support. Keeps the lid or door in an open position during instrument service or installation. (Standard on A style and C48, 49, 50, 248, 249, and 250 enclosures.)

H (Handle)

Stainless steel handle. Makes opening the door or lid of large enclosures easier.

BO (Blow Out)

Blow out disk provides pressure relief for the enclosure. The one way urethane flapper valve is installed in the bottom right rear corner of A and C style enclosures and the lower right corner of the back of B style enclosures.

D (Drain)

A removable drain plug can be installed in the bottom left front corner of A or C style enclosures and attached with a stainless steel ball chain. TRAKMOUNT style enclosures include a drain in the track as standard. (B style enclosures are self draining when the door is opened.)

SK (Seal Kit)

Silicone RTV sealant used to seal around holes drilled in the enclosure for process, signal, or power connections.

LL (Locking Latch)

A stainless steel locking latch with hasp replaces one of the standard latches. (Not available with PH option.)

PT (Phenolic Tag)

A 2" x 6" (50mm x 150mm) white phenolic tag with black lettering. Specify letter size and text.

SADDLEPAK® Instrument Stands

To complete the enclosure mounting, select an O'Brien SADDLEPAK support. The 40" (1015mm) tall floor stand is ideal for mounting enclosures. The cable mount is recommended to mount enclosures on the process line. Refer to the SADDLEPAK brochure for a complete list of options.

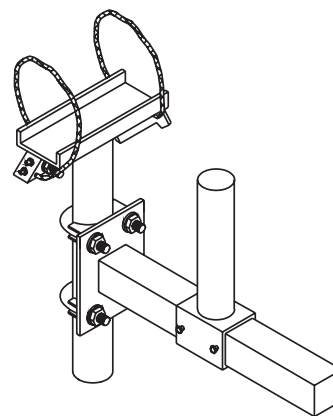

CP16M-US24M-A3M

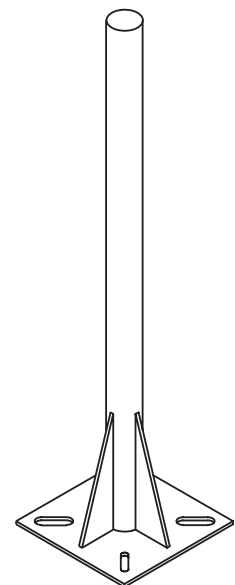

FP40

ELECTRIC HEATERS - HOW TO ORDER

T-Series Heater Model Number										
	T	X	#	#	##	XX	#	XX	X	X
Body Size										
6" (150mm) Standard Body (See Selection Guide on p.25)	S									
12" (305mm) Extended Body (See Selection Guide on p.25)	E									
T-Rating										
T3 – Standard S and E Body (maximum surface temperature 200°C/392°F)	3									
T4 – S Body Only (100W, 50F / 10C maintain only)	4									
Voltage										
115 VAC	1									
230 VAC	2									
277 VAC	3									
Wattage										
100 W (See Selection Guide on p.25)	10									
150 W (See Selection Guide on p.25)	15									
200 W (See Selection Guide on p.25)	20									
300 W (TE Body Only) (See Selection Guide on p.25)	30									
400 W (TE Body Only) (See Selection Guide on p.25)	40									
600 W (T2 and TE Body Only) (See Selection Guide on p.25)	60									
Approvals										
CI I, Div 2 Gp ABCD	D2									
CI I, Div 1 Gp CD	CD									
CI I, Div 1 Gp ABCD	AB									
EEX d IIC (T3 Option Only)	EX									
Thermostat										
50F (10C)	C									
75F (25C)	E									
100F (40C)	G									
125F (50C)	J									
150F (65C)	M									
Junction Box										
Standard	JS									
Increased Volume (Accommodate termination of additional tracer. Remote mounted with EX option)	J1									
Increased Volume (Accommodate termination of additional tracer. Remote mounted with EX option)	J2									
Orientation										
None (See Selection Guide on p.25)	9									
One Fin (See Selection Guide on p.25)	1									
Two Fins (See Selection Guide on p.25)	2									
Orientation										
Horizontal	H									
Vertical	V									
Tracer Power Connection Kits for T-Series Heater										
(Must select optional J1 or J2 junction box for additional volume)										
Y	CSA & FM Div 2 - B, N, J, P, JV or JN tracers									
TC	CSA Div 1 - B, N, J, or P tracers									

Dimensions

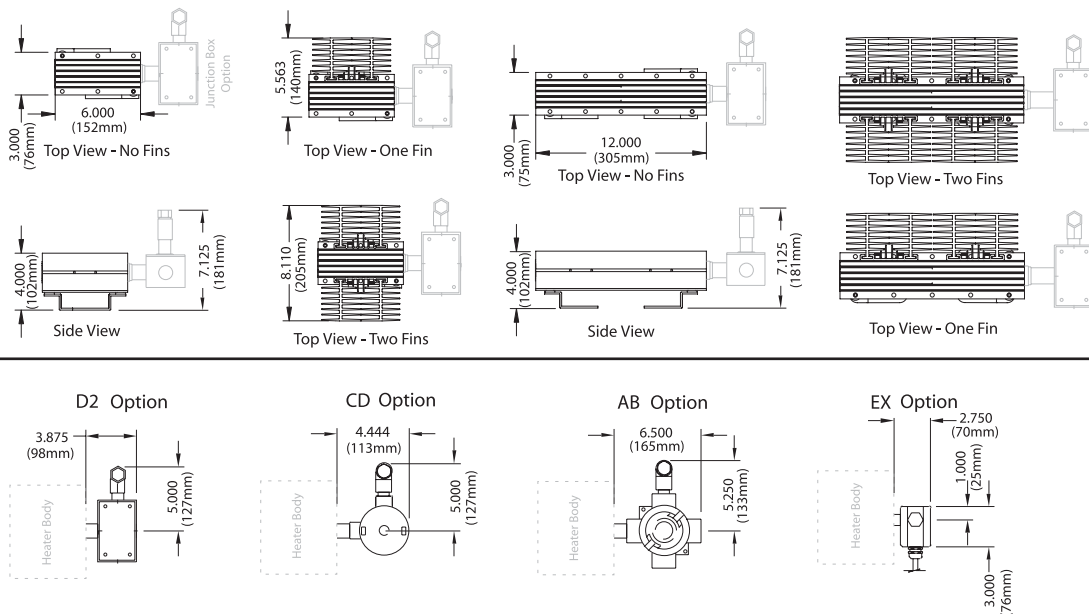

O'BRIEN T-SERIES HEATER SELECTION GUIDE

Thermostat		50F (10C)								75F (25C)				100F (40C)				125F (50C)				150F (65C)																			
Set Point		-60F(-50C)		-40F(-40C)		-20F(-30C)		0F(-20C)		-60F(-50C)		-40F(-40C)		-20F(-30C)		0F(-20C)		-60F(-50C)		-40F(-40C)		-20F(-30C)		0F(-20C)																	
		W	Size & Fins	W	Size & Fins	W	Size & Fins	W	Size & Fins	W	Size & Fins	W	Size & Fins	W	Size & Fins	W	Size & Fins	W	Size & Fins	W	Size & Fins	W	Size & Fins	W	Size & Fins																
A Style	A1	200	S1	150	S1	150	S1	100	S0	CF	200	S1	200	S1	150	S1	CF	CF	200	S2	200	S2	CF	CF	CF	CF															
	A2	300	E1	200	S1	150	S1	100	S0	300	E1	300	E1	200	S1	150	S1	400	E2	300	E1	300	E1	200	S2	400	E2	400	E2	300	E2	CF	CF	CF	300	E2					
	A3	300	E1	300	E1	200	S1	150	S1	400	E2	300	E1	300	E1	200	S1	400	E2	400	E2	300	E1	300	E1	CF	400	E2	400	E2	300	E2	CF	CF	CF	CF					
B or C Style Enclosure	3/203	200	S1	150	S1	150	S1	100	S0	300	E1	200	S1	200	S1	100	S1	300	E1	300	E1	200	S2	200	S2	300	E2	300	E2	200	S2	CF	CF	300	E2	300	E2				
	4/204	300	E1	200	S1	200	S1	150	S1	300	E1	300	E1	300	E1	200	S1	400	E2	400	E2	300	E1	300	E1	CF	400	E2	400	E2	300	E2	CF	CF	CF	CF					
	5/205	200	S1	150	S1	150	S1	100	S0	300	E1	200	S1	150	S1	100	S1	CF	300	E1	200	S2	200	S2	CF	CF	300	E2	200	S2	CF	CF	300	E2	300	E2					
	6/206	150	S1	100	S0	100	S0	100	S0	150	S1	150	S1	150	S1	100	S1	200	S2	200	S2	150	S1	150	S1	200	S2	200	S2	150	S1	300	E2	300	E2	200	S2	200	S2		
	7/207	300	E1	200	S1	150	S1	100	S0	CF	200	S1	200	S1	150	S1	CF	CF	CF	200	S2	CF	CF	CF	CF	CF	CF	CF	CF	CF	CF	CF	CF	CF	CF	CF					
	14/214	200	S1	200	S1	150	S1	100	S0	300	E1	300	E1	200	S1	150	S1	300	E1	300	E1	300	E1	200	S2	400	E2	300	E2	300	E2	300	E2	CF	CF	CF	300	E2			
	15/215	150	S1	150	S1	100	S0	100	S0	200	S1	200	S1	150	S1	150	S1	300	E1	300	E1	200	S2	150	S1	300	E2	300	E2	200	S2	300	E2	300	E2	300	E2	200	S2		
	22/222	150	S1	150	S1	100	S0	100	S0	200	S1	150	S1	150	S1	100	S1	200	S2	200	S2	150	S1	150	S1	300	E2	200	S2	200	S2	150	S1	300	E2	300	E2	200	S2	200	S2
	31/231	150	S1	150	S1	100	S0	100	S0	200	S1	150	S1	150	S1	100	S1	200	S2	200	S2	150	S1	150	S1	CF	200	S2	150	S1	150	S1	CF	CF	200	S2	200	S2			
	32/232	100	S0	100	S0	100	S0	100	S0	150	S1	100	S1	100	S1	100	S1	150	S1	150	S1	150	S1	100	S1	200	S2	150	S1	150	S1	150	S1	200	S2	200	S2	150	S2	150	S2
	33/233	200	S1	150	S1	150	S1	100	S0	200	S1	150	S1	150	S1	150	S1	CF	150	S1	150	S1	150	S1	CF	CF	CF	200	S2	CF	CF	CF	CF	CF	CF	CF	CF	CF			
	48/248	400	E1	300	E1	300	E1	150	S1	400	E2	400	E2	300	E1	300	E1	CF	CF	400	E2	300	E1	CF	CF	CF	400	E2	CF	CF	CF	CF	CF	CF	CF	CF	CF				
	49/249	300	E1	300	E1	200	S1	150	S1	400	E2	300	E1	300	E1	200	S1	400	E2	400	E2	300	E1	300	E1	CF	400	E2	400	E2	300	E2	CF	CF	CF	CF	CF	CF			
50/250	400	E1	400	E1	300	E1	150	S1	CF	CF	400	E2	300	E1	CF	CF	CF	CF	300	E1	CF	CF	CF	CF	CF	CF	CF	CF	CF	CF	CF	CF	CF	CF	CF	CF					
GRP	A501	CF	CF	CF	300	E1	CF	CF	CF	CF	CF	CF	CF	CF	CF	CF	CF	CF	CF	CF	CF	CF	CF	CF	CF	CF	CF	CF	CF	CF	CF	CF	CF	CF	CF	CF					
	A502	CF	CF	CF	300	E1	CF	CF	CF	CF	CF	CF	CF	CF	CF	CF	CF	CF	CF	CF	CF	CF	CF	CF	CF	CF	CF	CF	CF	CF	CF	CF	CF	CF	CF	CF					
	A701	300	E1	200	S1	150	S1	100	S0	300	E1	300	E1	200	S1	150	S1	300	E1	300	E1	300	E1	200	S2	400	E2	400	E2	300	E2	300	E2	CF	CF	CF	300	E2			
	A702	300	E1	200	S1	150	S1	100	S0	300	E1	300	E1	200	S1	150	S1	300	E1	300	E1	300	E1	200	S2	400	E2	400	E2	300	E2	300	E2	CF	CF	CF	300	E2			
	A705	300	E1	300	E1	200	S1	150	S1	400	E2	400	E2	300	E1	200	S1	CF	400	E2	400	E2	300	E1	CF	CF	400	E2	400	E2	CF	CF	CF	CF	CF	CF	CF				
	A706	300	E1	300	E1	200	S1	150	S1	400	E2	400	E2	300	E1	200	S1	CF	400	E2	400	E2	300	E1	CF	CF	400	E2	400	E2	CF	CF	CF	CF	CF	CF	CF				

CF = Consult Factory

Mounting - KEEP FINS VERTICAL

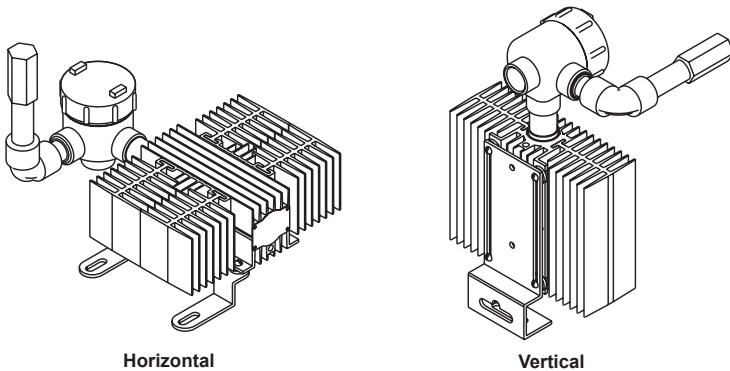

STEAM HEATER SELECTION GUIDE

		Steam Heater Selection Chart								
		0°F ambient			-30°F ambient			-60°F ambient		
		Steam Pressure (psig)			Steam Pressure (psig)			Steam Pressure (psig)		
Enclosure		50	100	150	50	100	150	50	100	150
	A1		S30 18"	S30 18"	S30 18"	S60 18"	S60 18"	S30 24"	S80 18"	S60 20"
		140°F	146°F	150°F	151°F	160°F	154°F	159°F	163°F	166°F
A2		S60 18"	S30 18"	S30 18"	S80 18"	S60 18"	S60 18"	S140 18"	S80 18"	S60 18"
		154°F	143°F	148°F	156°F	161°F	168°F	173°F	169°F	175°F
A3		S60 18"	S60 18"	S30 18"	S140 18"	S80 18"	S60 18"	S140 18"	S80 36"	S80 18"
		144°F	153°F	146°F	165°F	160°F	161°F	168°F	168°F	170°F
3, 203		S30 18"	S30 18"	S30 18"	S60 18"	S30 26"	S30 20"	S80 24"	S60 18"	S30 18"
		140°F	152°F	160°F	157°F	158°F	161°F	166°F	169°F	175°F
4, 204		S60 18"	S30 18"	S30 18"	S80 18"	S60 18"	S60 18"	S140 18"	S80 24"	S60 24"
		147°F	147°F	153°F	154°F	158°F	164°F	168°F	168°F	169°F
5		S30 18"	S30 18"	S30 18"	S60 18"	S30 26"	S30 20"	S60 24"	S60 18"	S60 18"
		140°F	146°F	151°F	154°F	152°F	154°F	159°F	163°F	171°F
6		S30 18"	S30 18"	S30 18"	S30 20"	S30 18"	S30 18"	S30 28"	S30 22"	S30 18"
		149°F	157°F	163°F	150°F	157°F	163°F	159°F	163°F	166°F
7		S60 18"	S30 18"	S30 18"	S80 18"	S60 18"	S60 18"	S140 9"	S80 18"	S60 18"
		151°F	146°F	154°F	159°F	163°F	174°F	174°F	173°F	173°F
C 14, 214		S30 18"	S30 18"	S30 18"	S60 18"	S60 18"	S30 24"	S80 24"	S60 24"	S60 18"
		140°F	150°F	154°F	154°F	165°F	161°F	163°F	168°F	175°F
D 15, 215		S30 18"	S30 18"	S30 18"	S60 18"	S30 18"	S30 18"	S60 24"	S60 18"	S30 24"
		148°F	159°F	168°F	164°F	159°F	168°F	168°F	179°F	174°F
B 22, 222		S30 18"	S30 18"	S30 9"	S60 18"	S30 18"	S30 18"	S60 18"	S30 24"	S30 18"
		152°F	164°F	164°F	169°F	164°F	174°F	169°F	170°F	174°F
31, 231		S30 18"	S30 18"	S30 18"	S30 20"	S30 18"	S30 18"	S30 28"	S30 22"	S30 18"
		149°F	157°F	163°F	150°F	157°F	163°F	159°F	163°F	166°F
32, 232		S30 18"	S30 9"	S30 9"	S30 18"	S30 9"	S30 9"	S30 18"	S30 18"	S30 9"
		164°F	168°F	179°F	164°F	168°F	179°F	164°F	178°F	179°F
33, 233		S30 18"	S30 18"	S30 18"	S30 28"	S30 20"	S30 18"	S60 18"	S60 18"	S30 30"
		145°F	153°F	158°F	150°F	152°F	158°F	161°F	172	166°F
48, 248		S60 22"	S30 28"	S30 24"	S140 18"	S80 24"	S80 18"	S190 18"	S140 18"	S80 36"
		142°F	145°F	146°F	163°F	156°F	161°F	169°F	173°F	170°F
49, 249		S60 18"	S60 18"	S30 18"	S140 18"	S80 18"	S60 18"	S140 18"	S80 36"	S80 18"
		144°F	153°F	146°F	165°F	161°F	161°F	166°F	168°F	170°F
50, 250		S80 18"	S60 18"	S60 18"	S140 18"	S140 18"	S80 24"	S190 24"	S190 18"	S140 18"
		140°F	145°F	147°F	156°F	165°F	158°F	164°F	175°F	174°F

Consult factory to size heaters for recirculated heat transfer fluids.

Instructions

All heating systems are designed to maintain 50°F under the given conditions.

- Check physical size limitations within enclosure. (Refer to the component compatibility guide on pages 17-18.)

Heater Model #	S80	26"	³ / ₈ " connecting tubing length
	152		

Enclosure temp. at 110°F ambient

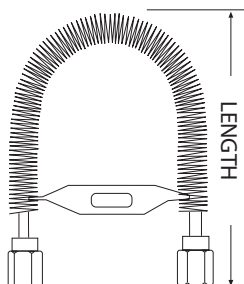

Model	Length
S30	4 ³ / ₄ " (120mm)
S60	4 ³ / ₄ " (120mm)
S80	4 ³ / ₄ " (120mm)
S140	7 ³ / ₄ " (200mm)
S190	10 ³ / ₄ " (200mm)
S240	13 ³ / ₄ " (350mm)

HCV50/100

Heater control valves for 50°F and 100°F setpoints.

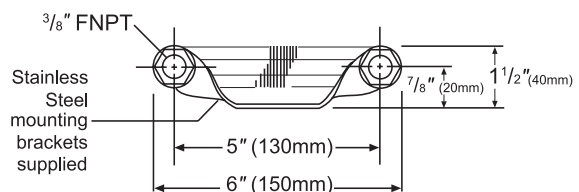
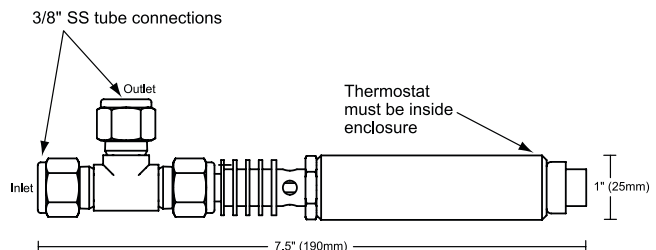

Factory Installation

When describing the location for factory installed options O'Brien uses the coordinate system described below. For example, to mount an "MK7" centered side to side on the bottom and 11.5" from the outside front of a "C31" enclosure the coordinates would be: $x=0, y=-5, z=11.5$.

You may use this system to describe mounting locations. For many instruments, O'Brien can suggest a mounting location if you provide the make and model number. You may also use a verbal description to indicate a location, e.g. "Center the W3 window on the right side of the C14 lid."

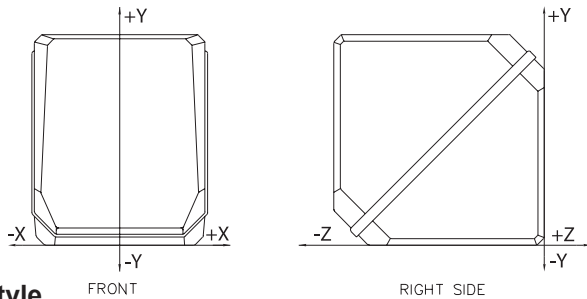

A Style

- XYZ origin is on the outside back-bottom centerline (Note: +Z is impossible, -Y is impossible)

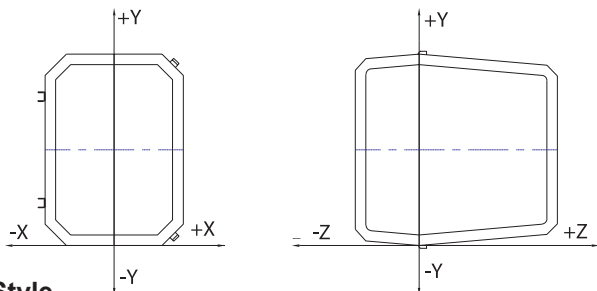

B Style

- XYZ origin is on the outside center at the parting line (Note: -Y is impossible)

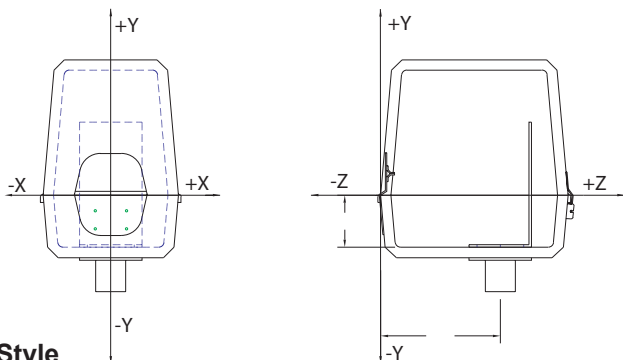

C Style

- XYZ origin is on the outside front center at the parting line (Note: -Z is impossible)

Plate Drilling

Hole locations are specified by measuring distance on X and Y axis.

Example: a 2" hole centered in a Parting Plate would be 2" dia. @ $X=0, Y=0$

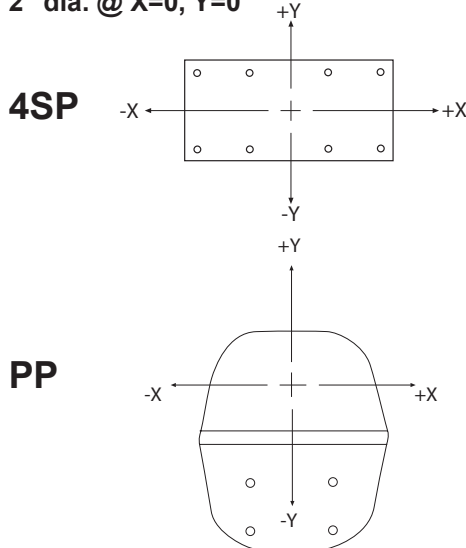

English/Metric Conversions

- Inches to Millimeters = Inch x 25.4
- Feet to Meters = F/3.28
- °F to °C = $(°F-32) \times 5/9$

Steam Table

Gauge Pressure (PSIG)	Steam Temp. (°F)	Gauge Pressure (PSIG)	Steam Temp. (°F)
0	212.00	70	316.25
1	216.32	80	324.12
2	219.44	90	331.36
5	227.96	100	337.90
10	240.07	110	344.33
15	250.30	120	350.21
20	259.28	130	355.76
25	267.25	140	360.50
30	274.44	150	365.99
40	287.07	160	370.75
50	297.97	180	379.67
60	307.60	200	387.89

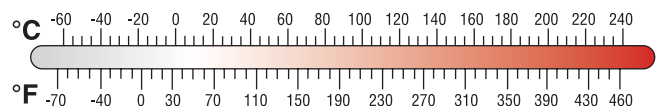

Customer Service

O'Brien's reputation as a customer oriented problem solver has been long recognized.

Our customer-oriented approach offers:

- Responsive, knowledgeable personnel.
- Unparalleled delivery service.
- Dependable, tested results of all product lines.
- On-line order status and shipment tracking.

ISO 9001

Unparalleled quality system to current ISO 9001 standards.

O'Brien's adherence to recognized international standards is your strongest assurance of our quality.

Total Solution

O'Brien products and solutions improve instrument accuracy. Our total engineering package will reduce field installation costs and provide a dependable solution for your needs.



USA:

O'Brien Corporation
1900 Crystal Industrial Ct.
St. Louis, MO 63114
Ph: +1 (314) 236-2020
Fax: +1 (314) 236-2080

BELGIUM:

Mallekotstraat 65
B 2500 Lier Belgium
Ph: +32 (0)3 491 9875
Fax: +32 (0)3 491 9876

CHINA:

Suite1605A, 16F Feidiao
International Building
1065 Zhao Jia Bang Road
Shanghai 200030
Ph: +86 21 51581635
Fax: +86 21 51581686

SINGAPORE:

1 Kaki Bukit Road 1
#02-44, Enterprise One
Singapore 415934
Ph: +65 6387 8907
Fax: +65 6387 9808

obcorp@obcorp.com
www.obcorp.com

Specifications subject to change without notice.

