

XMTC

User's Manual



XMTC

Thermal Conductivity Binary Gas Transmitter

User's Manual

910-217 Rev. G
October 2013



www.ge-mcs.com

©2013 General Electric Company. All rights reserved.
Technical content subject to change without notice.

[no content intended for this page]

Information Paragraphs

Note: *These paragraphs provide information that provides a deeper understanding of the situation, but is not essential to the proper completion of the instructions.*

IMPORTANT: *These paragraphs provide information that emphasizes instructions that are essential to proper setup of the equipment. Failure to follow these instructions carefully may cause unreliable performance.*



CAUTION! This symbol indicates a risk of potential minor personal injury and/or severe damage to the equipment, unless these instructions are followed carefully.



WARNING! This symbol indicates a risk of potential serious personal injury, unless these instructions are followed carefully.

Safety Issues



WARNING! It is the responsibility of the user to make sure all local, county, state and national codes, regulations, rules and laws related to safety and safe operating conditions are met for each installation.

Auxiliary Equipment

Local Safety Standards

The user must make sure that he operates all auxiliary equipment in accordance with local codes, standards, regulations, or laws applicable to safety.

Working Area



WARNING! Auxiliary equipment may have both manual and automatic modes of operation. As equipment can move suddenly and without warning, do not enter the work cell of this equipment during automatic operation, and do not enter the work envelope of this equipment during manual operation. If you do, serious injury can result..



WARNING! Make sure that power to the auxiliary equipment is turned OFF and locked out before you perform maintenance procedures on the equipment.

Auxiliary Equipment (cont.)

Qualification of Personnel

Make sure that all personnel have manufacturer-approved training applicable to the auxiliary equipment.

Personal Safety Equipment

Make sure that operators and maintenance personnel have all safety equipment applicable to the auxiliary equipment. Examples include safety glasses, protective headgear, safety shoes, etc.

Unauthorized Operation

Make sure that unauthorized personnel cannot gain access to the operation of the equipment.

Environmental Compliance

Waste Electrical and Electronic Equipment (WEEE) Directive

GE Measurement & Control Solutions is an active participant in Europe's *Waste Electrical and Electronic Equipment* (WEEE) take-back initiative, directive 2002/96/EC.

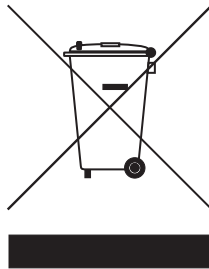

The equipment that you bought has required the extraction and use of natural resources for its production. It may contain hazardous substances that could impact health and the environment.

In order to avoid the dissemination of those substances in our environment and to diminish the pressure on the natural resources, we encourage you to use the appropriate take-back systems. Those systems will reuse or recycle most of the materials of your end life equipment in a sound way.

The crossed-out wheeled bin symbol invites you to use those systems.

If you need more information on the collection, reuse and recycling systems, please contact your local or regional waste administration.

Visit <http://www.ge-mcs.com/en/about-us/environmental-health-and-safety/1741-weee-req.html> for take-back instructions and more information about this initiative.

Chapter 1. Features and Capabilities

1.1	Introduction	1
1.2	Basic Features	1
1.3	Theory of Operation	2
1.4	System Description	3
1.4.1	Packaging and Temperature Rating	3
1.4.2	2-Port (Sealed Reference Gas) Version	4
1.4.3	4-Port (Flowing Reference Gas) Version	5
1.4.4	Sample System	6
1.4.5	Extra Cable (optional)	6
1.4.6	Power Supply (optional)	6
1.4.7	TMO2D-TC Display (optional)	6
1.4.8	XDP Display (Optional)	6
1.5	Typical Applications	7

Chapter 2. Installation

2.1	Introduction	9
2.2	Mounting the XMTC Transmitter	9
2.3	Mounting the Sample System	10
2.3.1	Manual, 2-Port (Sealed Reference Gas) Sample System	10
2.3.2	Manual, 4-Port (Flowing Reference Gas) Sample System	11
2.3.3	Sample Systems with Automatic Switching	11
2.4	Wiring the XMTC Transmitter	12
2.4.1	Grounding the Enclosure	12
2.4.2	CE Mark Compliance	13
2.4.3	Cable Specifications	13
2.4.4	Wiring the Signal Connections	14
2.5	Connecting to Other Components	17
2.5.1	PS5R-C24 Power Supply	17
2.5.2	TMO2D Display	18
2.5.3	XDP Display	18
2.5.4	Moisture Series Analyzers	18

Chapter 3. Operation and Programming

3.1 Introduction19

3.2 Powering Up the XMTC.....19

3.3 Starting the Sample Gas19

3.4 Programming with IDM™20

3.5 The Edit Functions Menu.....20

3.6 Field Cal21

 3.6.1 Perform Cal21

 3.6.2 Configure Cal23

 3.6.3 Calibration Drifts.....26

 3.6.4 Clear Calibration27

 3.6.5 Hold Last Value27

3.7 4-20 mA Output28

 3.7.1 4-20 mA Range28

 3.7.2 4 and 20 mA Cal29

 3.7.3 4-20 mA % Test.....30

 3.7.4 % Gas Test.....31

3.8 Error Handler31

 3.8.1 Total Drift Error.....32

 3.8.2 Drift/Cal Error33

 3.8.3 Gas mV Under/Over Range.....34

 3.8.4 Gas % Under/Over Range34

3.9 Factory Cal35

 3.9.1 Edit # of Points35

 3.9.2 Edit Point X.....36

3.10 The Advanced Option.....37

 3.10.1 Fast Response38

 3.10.2 Language38

 3.10.3 Meter ID40

Chapter 4. Calibration

4.1 Introduction43

4.2 Gas Ranges and Types43

4.3 Required Equipment and Materials44

4.4 Preparing the Transmitter for Calibration.....45

4.5 2-Port (Sealed Reference Gas) Calibration46

4.6 4-Port (Flowing Reference Gas) Calibration47

Chapter 5. Specifications

5.1 Performance49

5.2 Functional.....50

5.3 Physical.....50

5.4 Accessories.....51

Appendix A. Supplemental Information

A.1 Ordering Information 53
 A.2 Calibration Specification Ordering Information 54
 A.3 XMTC PCB Subassemblies 55
 A.4 Sample Calibration Sheet. 56
 A.5 Relative Thermal Conductivity of Common Gases 57

Appendix B. Typical Applications

B.1 H2 in N2 in Heat Treat Furnace Atmospheres 59
 B.1.1 Problem 59
 B.1.2 Equipment 59
 B.1.3 Basic Operating Procedure 60
 B.1.4 Permanent Installation 61
 B.1.5 Specifications 61
 B.1.6 Detailed Operating Procedure 61
 B.2 H2 Purity in H2-Cooled Electricity Generator 64
 B.2.1 Problem 64
 B.2.2 Equipment 64
 B.2.3 Basic Operating Procedure 65
 B.2.4 How Previously Handled 66
 B.2.5 Permanent Installation 66
 B.2.6 Specifications 66
 B.2.7 Detailed Operating Procedure 66

Appendix C. Installation and Wiring Diagrams

Appendix D. The Enhanced Advanced Option

D.1 Entering the Enhanced Advanced Option 85
 D.2 Heater 86
 D.3 Balance Bridge 88
 D.4 Factory Settings 89
 D.5 Temperature Comp. 91

Appendix E. CE Mark Compliance

E.1 CE Mark Requirements 93
 E.2 EMI Filter Board 94
 E.3 Wiring the Signal Connections for the Weatherproof Version. 95
 E.4 Wiring the Signal Connections for the Explosion/Flameproof Version. 97

Appendix F. Certifications

F.1 EC-Type Examination Certificate 99
 F.2 IECEX Certificate of Conformity 102

[no content intended for this page]

Chapter 1. Features and Capabilities

1.1 Introduction

This chapter introduces you to the features and capabilities of the GE *XMTC Thermal Conductivity Transmitter*. The following topics are discussed:

- Basic features of the XMTC thermal conductivity transmitter
- Theory of operation
- A system description of the XMTC, available options, and sample systems Information on optional components is also provided, including a 24 VDC power supply, extra cable, and the TMO2D-TC Display.
- A brief discussion of typical XMTC applications

XMTC technical specifications can be found in Chapter 5, *Specifications*. Ordering information can be found in Appendix A, *Supplemental Information*.

1.2 Basic Features

- The XMTC is a transmitter that measures the thermal conductivity of a binary (or pseudo-binary) gas mixture containing hydrogen, carbon dioxide, methane or helium, and provides a 4-20 mA signal proportional to the concentration of one of the gases in the mixture. It offers several unique design features:
- Ultra-stable thermistors and a temperature-controlled measuring cell (55°C/131°F standard, 70°C/158°F optional) provide excellent zero and span stability, as well as tolerance of ambient temperature variations.
- The measuring cell design makes it highly resistant to contamination and flow vibrations. Since it has no moving parts, the transmitter can handle the shock and vibration found in many industrial applications.
- A 2-port version for measurement of zero-based gas mixtures using a sealed reference gas (air or nitrogen) and a 4-port version for measurement of zero-suppressed gas mixtures (and some other special calibrations) using a flowing reference gas are available.
- The XMTC modular construction means that the unit can be field-calibrated quickly and easily. If desired, the plug-in measuring cell can be replaced with a pre-calibrated spare in minutes.
- The XMTC transmitter, with weatherproof or explosion-proof packaging, is designed to be installed as close as possible to the process sample point. It can be located up to 4000 ft (1200 m) from a display or recorder, using inexpensive unshielded cable.

1.3 Theory of Operation

The XMTC measures the concentration of a gas in a binary gas mixture by measuring the thermal conductivity of the sample gas and comparing it to the thermal conductivity of a selected reference gas.

Two ultra-stable, glass-coated thermistors are used: one in contact with the sample gas, and the other in contact with a selected reference gas. The thermistors are mounted so that they are in close proximity to the stainless steel walls of the sample chamber. The entire sensor is heated to 55°C/131°F, (or 70°C/158°F) and the thermistors are heated above the sensor temperature using a constant current source. The thermistors lose heat to the walls of the sample chamber at a rate that is proportional to the thermal conductivity of the gas surrounding them. Thus, each thermistor will reach a different equilibrium temperature. The temperature difference between the two thermistors is detected in an electrical bridge circuit. It is then amplified and converted to a 4-20 mA output proportional to the concentration of one of the constituents of the binary gas mixture. For example:

- To measure 0 to 25% H₂ in N₂, the reference gas would be air (2-port version, sealed reference gas), and for calibration, the zero gas would be 100% N₂ (i.e. 0% H₂) and the span gas would be 25% H₂ in N₂.
- To measure 90-100% H₂ in N₂, the reference gas would be 100% H₂ (4-port version, flowing reference gas), the zero gas would be 90% H₂ in N₂, and the span gas would be 100% H₂ (the same as the reference gas).

Note: *The XMTC has polarity adjustment jumpers which permit the measurement of gases (such as CO₂) that have a relative thermal conductivity less than air/nitrogen.*

Appendix A, *Supplemental Information*, contains a table of *Relative Thermal Conductivity of Common Gases*. Figure 1 below shows some of these values graphically.

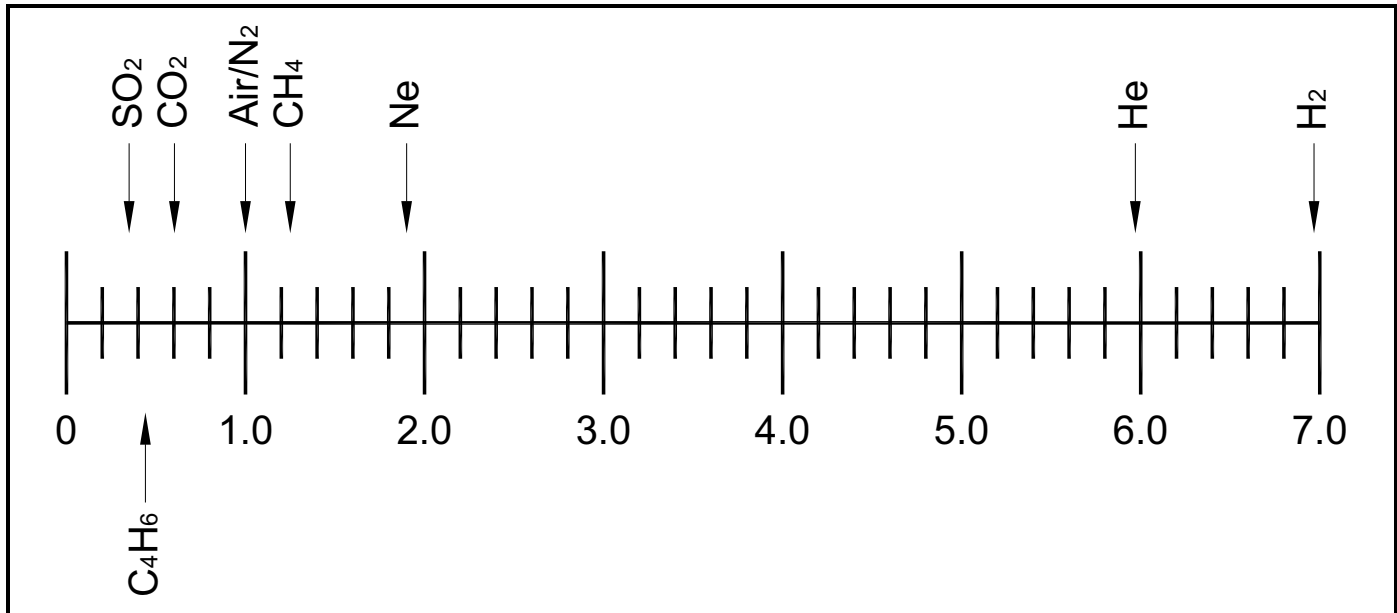

Figure 1: Relative Thermal Conductivity of Some Common Gases

1.4 System Description

The basic XMTC measurement system consists of an XMTC Transmitter mounted in a sample system. The sample system is mandatory, and can either be provided by GE or constructed according to GE recommendations. The XMTC is supplied with a standard 10 ft (3 m), 4-wire cable for power and output connections, with lengths up to 4000 ft (1200 m) available. Optionally available from GE are a 24-VDC power supply to power the XMTC, a remote display with programming and control capabilities, and several analyzers which can be interfaced with the XMTC.

1.4.1 Packaging and Temperature Rating

The XMTC transmitter is self-contained, consisting of the thermal conductivity sensor and associated electronics. It requires 24 VDC power (1.2 A maximum at power-up), and provides a 4-20 mA output signal proportional to the concentration of one of the gases in the binary sample gas mixture.

The XMTC is designed to be installed in a sample system as close as possible to the process sample point. Thus, it is available in two environmental packages:

- Weatherproof
- Explosion-proof (with the addition of flame arrestors to the sample/reference gas inlet and outlet)

Each environmental package is available in a standard 2-port (sealed reference gas) version, or an optional 4-port (flowing reference gas) version.

The XMTC is supplied with a standard measurement cell operating temperature of 55°C (131°F). An optional 70°C (158°F) cell operating temperature is available.

Note: *The 70°C (158°F) operating temperature should be selected only for high temperature applications, because it results in reduced sensitivity.*

1.4.2 2-Port (Sealed Reference Gas) Version

This standard configuration (see *Figure 2* below) is used for zero-based ranges with air or nitrogen at atmospheric pressure as the balance or background gas. It utilizes air with desiccant in a factory sealed chamber as the reference gas. The following standard ranges and gases are available:

Ranges:		Gases:	
0-2%		H ₂ in N ₂ or air	
0-5%		CO ₂ in N ₂ or air (min. range 0-5% CO ₂)	
0-10%		SO ₂ in air (min. range 0-2% SO ₂)	
0-25%		He in N ₂ or air	
0-50%		Argon in N ₂ or air	
0-100%			
50-100%			
80-100%			
90-100%			
95-100%			
98-100%			

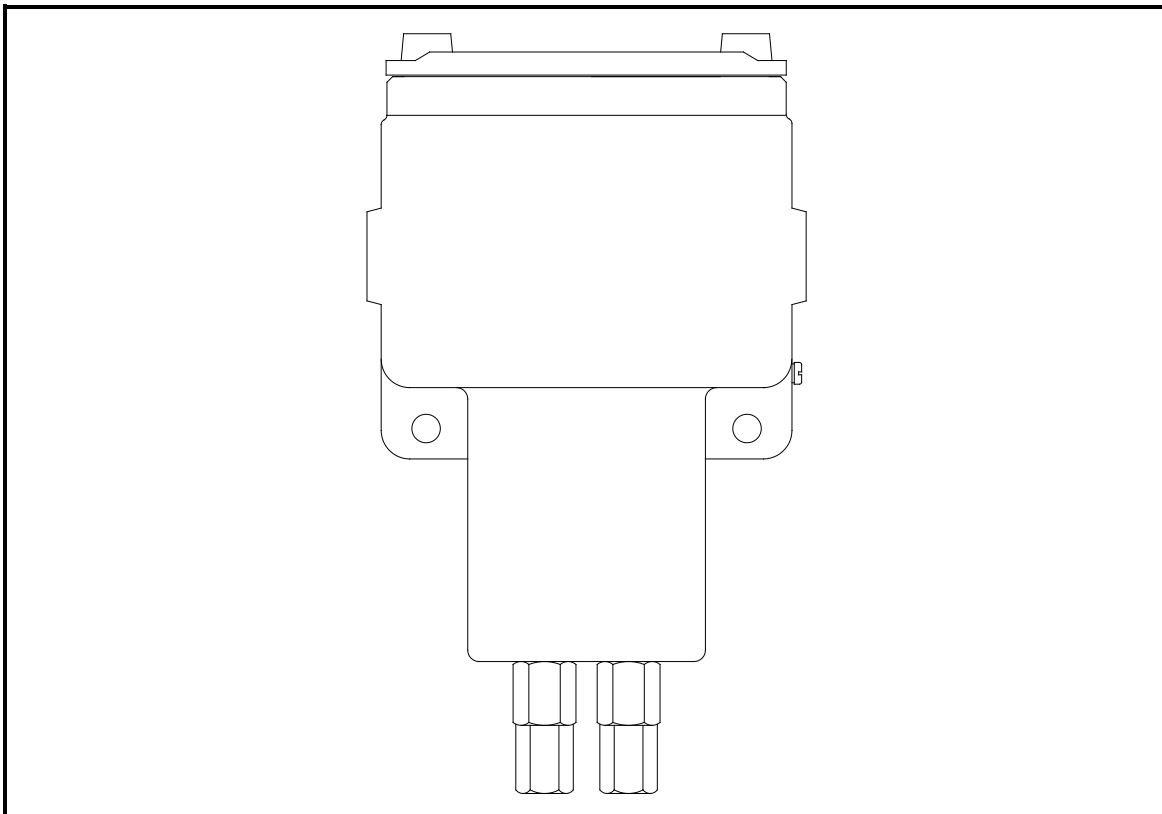

Figure 2: 2-Port (Sealed Reference Gas) XMTC

1.4.3 4-Port (Flowing Reference Gas) Version

This optional configuration shown in *Figure 3* below is used for zero-suppressed ranges and some other special applications. Typically, a flowing reference gas of 100% H₂ or CO₂ is used. The following standard ranges and gases are available:

Ranges:	90 to 100%	Gases:	H ₂ in N ₂
	80 to 100%		CO ₂ in N ₂ or air
			He in N ₂ or air

Note: For factory calibration pricing on the standard ranges and gases, or for pricing on other zero-suppressed ranges and gases, please consult the factory.

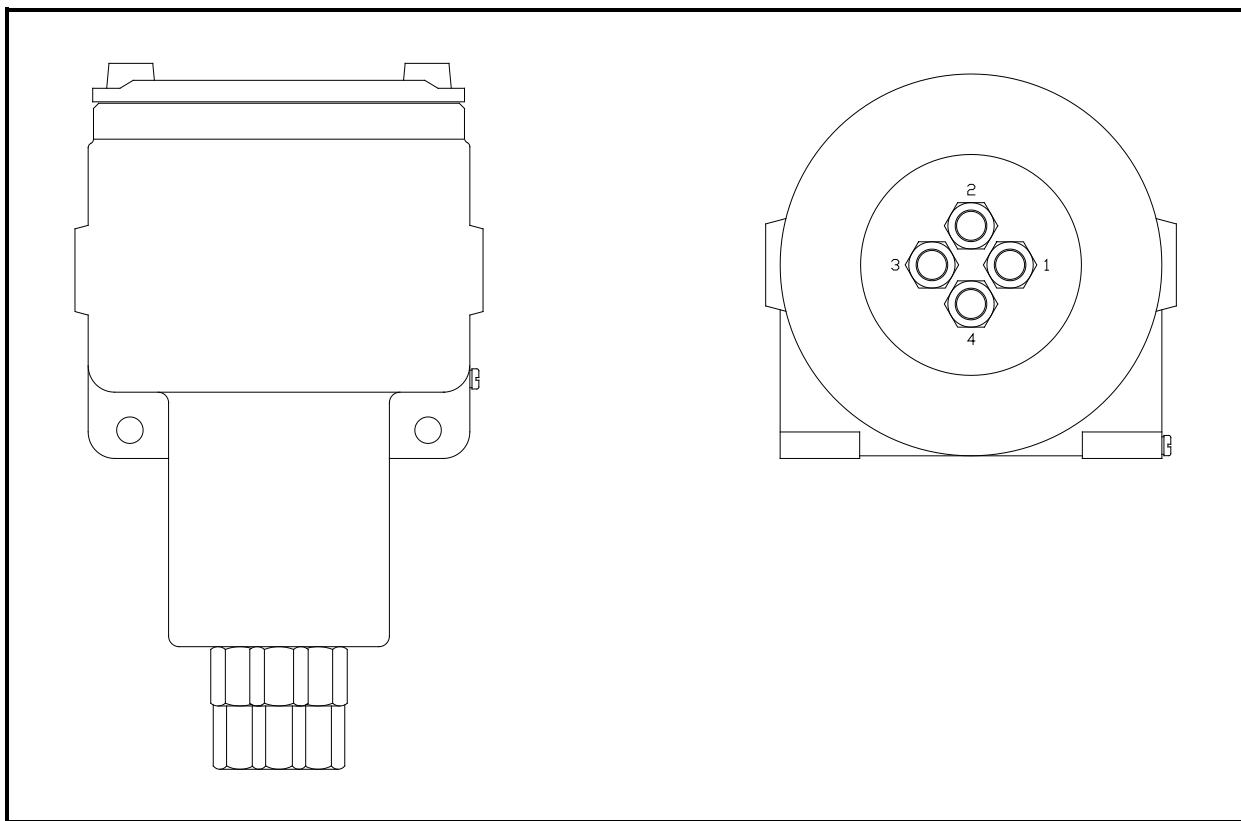

Figure 3: 4-Port (Flowing Reference Gas) XMTC

1.4.4 Sample System

Use of a sample system is mandatory with the XMTC. The design of the sample system depends on the conditions of the sample gas and the requirements of the application. In general, a sample system must deliver a clean, representative sample to the XMTC at a temperature, pressure and flow rate that are within acceptable limits. Standard XMTC sample conditions are as follows:

- Temperature less than 50°C (122°F) for 55°C cell operating temperature
- Atmospheric pressure
- Flow rate 0.5 SCFH (250 cc/min)

GE offers sample systems for a wide variety of applications. Two standard sample systems for the XMTC are shown in Chapter 2, *Installation*. For assistance in designing your own sample system, please consult the factory.

1.4.5 Extra Cable (optional)

GE provides a 10 ft (3 m) length of 4-wire, color-coded cable with each XMTC to connect the power and outputs. Optional cables are available in lengths up to 4000 ft (1200 m). If you are using your own cable, refer to *Table 1 on page 13* for recommendations.

1.4.6 Power Supply (optional)

The XMTC requires 24 VDC at a maximum start-up current of 1.2 A. The GE PS5R-C24 power supply converts 100/120/220/240 VAC to the required 24 VDC for the XMTC.

1.4.7 TMO2D-TC Display (optional)

The GE TMO2D-TC Display provides a two-line x 24 character back-lit LCD. It also features display and option programming, recorder outputs, alarm relays, and relays for driving sample system solenoids for automatic zero and span calibration of the XMTC. For information on the TMO2D-TC, please contact GE.

1.4.8 XDP Display (Optional)

The GE XDP Explosion-proof Display provides an integral, voltage-stabilized 24 VDC power supply, a 3-digit display with adjustable 4-20 mA input range, two SPDT alarm relays rated for 1 A/250 VAC, and a 4-20 mA output that is isolated from the input and adjustable to a second independent range if required. For information on the XDP, please contact GE.

1.5 Typical Applications

The XMTC can be used in a wide variety of industrial applications where it is necessary to measure the concentration of one component of a binary gas mixture. It can also be used in pseudo-binary gas mixtures where the ratio of concentrations of the background gas components remains constant, and in gaseous mixtures where the thermal conductivity of the gas of interest is significantly different from that of the background gas. Some typical industries and applications include:

- Metals Industry -
H₂ in heat treat furnace atmospheres
- Electric Power Industry -
H₂ in generator cooling systems
- Gas Production Industry -
Purity monitoring of argon, hydrogen, nitrogen, helium
- Chemical Industry -
H₂ in ammonia synthesis gas
H₂ in methanol synthesis gas
H₂ in chlorine plants
- Food Industry -
CO₂ in fermentation processes
Ethylene Oxide (ETO) sterilization
- Steel Industry -
H₂ in blast furnace top gas
- Petroleum Industry -
H₂ in hydrocarbon streams

Two very common applications are:

- H₂ in N₂ in heat treat furnace atmospheres: zero-based 0-25% H₂, 2-Port (sealed reference gas, air)
- H₂ purity in H₂ electricity generator cooling: zero-suppressed, 80-100% H₂, 4-Port (flowing reference gas, 100% H₂)

For more details on these applications, refer to Appendix B, *Applications*. For details on applications not shown in Appendix B, or if you wish to discuss your own application, please contact GE.

[no content intended for this page]

Chapter 2. Installation

2.1 Introduction

This chapter describes how to install the XMTC transmitter and its sample system. It also contains information on connecting the XMTC to optional system components. The following topics are discussed:

- Mounting the XMTC transmitter
- Installing a GE sample system
- Wiring the XMTC transmitter
- Connecting the XMTC transmitter to optional components

2.2 Mounting the XMTC Transmitter

This section applies only if you are mounting the XMTC transmitter in a sample system that has not been supplied by GE.

Your sample system should deliver a clean, representative sample to the XMTC at the proper temperature, pressure and flow rate. This usually means a clean, dry sample (free of solid and liquid particulates) at atmospheric pressure; a temperature no greater than 50°C (122°F); and a flow rate of approximately 0.5 SCFH (250 cc/min). Since factory calibration of the sensor is at atmospheric pressure and 0.5 SCFH, higher or lower operating pressure may necessitate field-calibration adjustment.

A simple sample system for a 2-Port XMTC might have inlet and outlet flow-regulating needle valves, a flow meter, and a pressure gauge, in addition to the XMTC transmitter.

The XMTC transmitter should be mounted in the sample system so that it is upright and level to within $\pm 15^\circ$. Also, provide at least 9 in. (230 mm) of clearance above the top cover of the transmitter to allow access to the transmitter printed circuit board (PCB) for calibration and maintenance. For a 2-Port XMTC, connect the sample system *Sample Inlet* and *Sample Outlet* ports to the appropriate XMTC port. For a 4-Port system, also connect the *Reference Inlet* and *Reference Outlet* ports to the appropriate XMTC ports.

Note: Refer to Appendix C, Installation and Wiring Diagrams, for port locations and other information.



WARNING! Be sure your installation conforms to all safety and electrical code requirements.

2.3 Mounting the Sample System

You can order a complete sample system from the factory. This includes the XMTC transmitter and all necessary components and sample tubing mounted on a metal panel. Several standard sample systems are available, and custom-designed sample systems can be built to your exact specifications.

Mount the sample system as close to the process sample point as possible. Once the sample system is mounted, connect all inlet and outlet lines via the 1/4" compression fittings on the sample system. The sample line leading from the process to the sample system should be of 1/4" stainless steel tubing, and should be as short as possible in order to ensure a representative sample.

Following are descriptions of two standard sample systems:

2.3.1 Manual, 2-Port (Sealed Reference Gas) Sample System

Figure 4 below shows a basic sample system for a 2-Port (sealed reference gas) XMTC. This sample system consists of inlet needle valves for sample, zero, and span gases; a ball valve; a 2-port XMTC; a pressure gauge; and a flowmeter. All components are mounted on a painted steel plate. Other components could be added for filtration (filter/coalescer), pressure control (regulator), or flow control (pump).

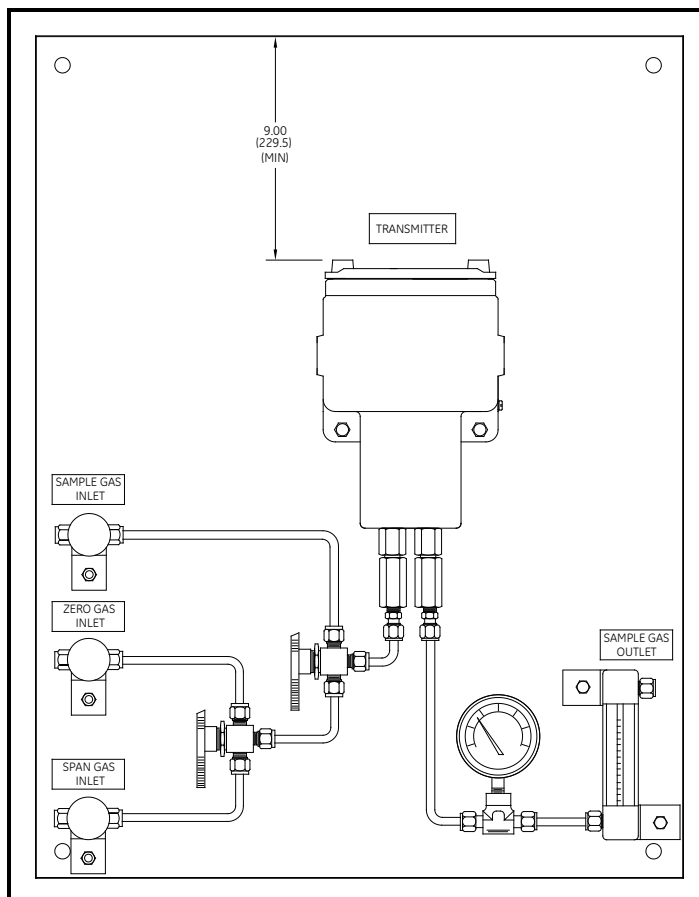

Figure 4: Basic 2-Port Sample System (732-164)

2.3.2 Manual, 4-Port (Flowing Reference Gas) Sample System

Figure 5 below shows a basic sample system for a 4-Port (flowing reference gas) XMTC. This sample system consists of inlet needle valves for sample, reference, and calibration gases; a 4-port XMTC; two pressure gauges; and two flow meters. All components are mounted on a painted steel plate. Other components could be added for filtration (filter/coalescer), pressure control (regulator), or flow control (pump).

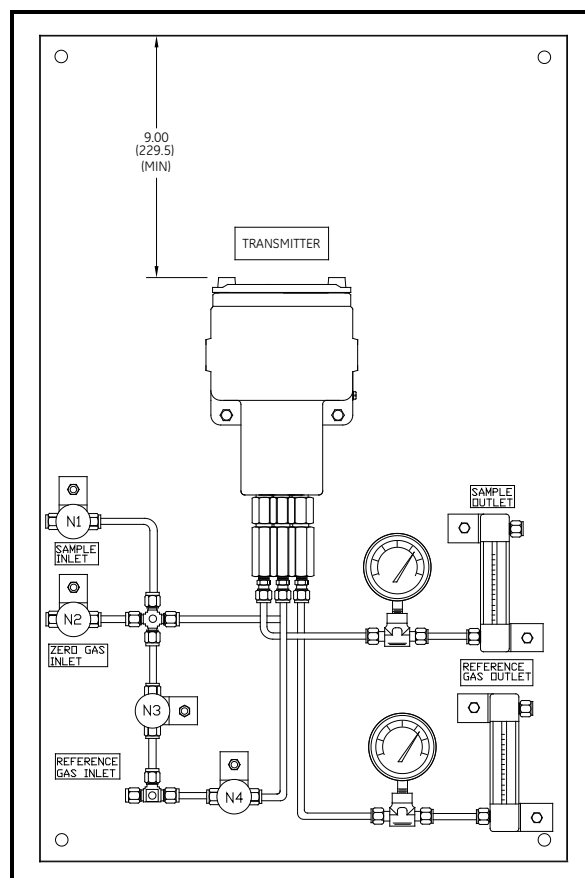

Figure 5: Basic 4-Port Sample System (732-028)

2.3.3 Sample Systems with Automatic Switching

Also available from GE are sample systems with electrically-actuated, three-way solenoid valves. When used in conjunction with a TMO2D or XDP Display (with the Auto Cal option), these systems allow automatic switching of sample, zero, span, and reference gases during operation and calibration. Refer to Appendix B, *Applications*, for details on sample systems designed by GE for specific applications.

2.4 Wiring the XMTC Transmitter



CAUTION! Always apply power to the XMTC immediately after installation, especially when it is mounted outdoors or in a humid area.

This section describes how to wire the XMTC for 24 VDC power, RS232 communication, 4-20 mA output, and optional devices.

2.4.1 Grounding the Enclosure



WARNING! The XMTC transmitter enclosure must be properly grounded.

Connect the external ground screw on the XMTC enclosure (see *Figure 6* below) to a suitable earth ground.

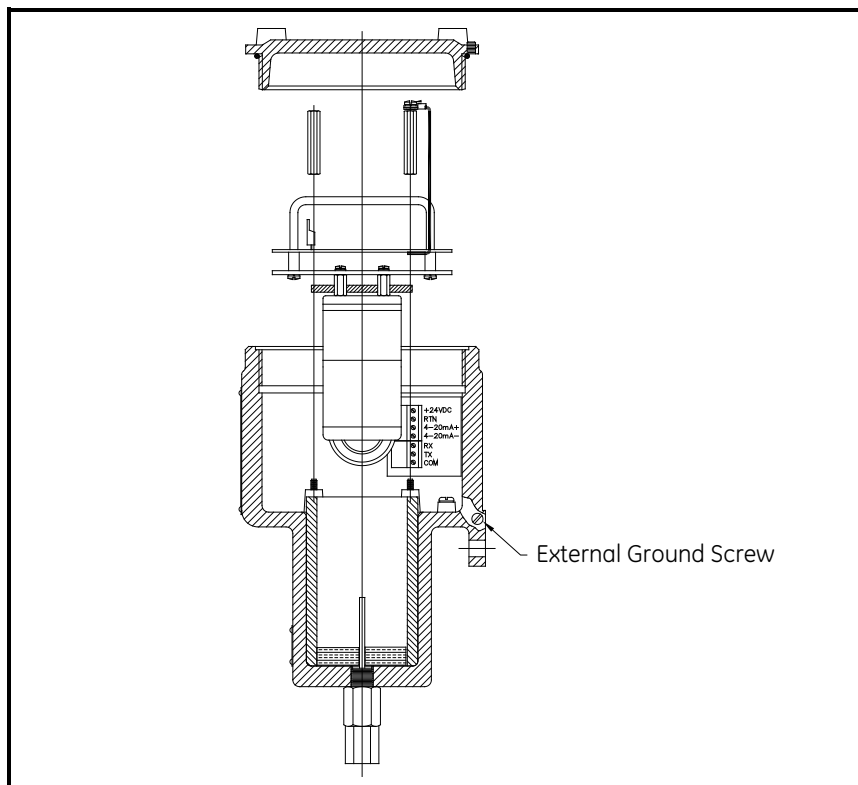

Figure 6: Ground Screw Location

2.4.2 CE Mark Compliance



WARNING! To meet CE Mark requirements, you must shield and ground all electrical cables as described in *Appendix E*.



WARNING! CE Mark compliance is required for all units installed in EU countries.



WARNING! Cable entries of an approved flameproof design are required. These must be installed according to the manufacturer's instructions. The choice of cable entry device may limit the overall installation category achieved.

2.4.3 Cable Specifications

Table 1 below shows the transmitter wiring connections for the standard GE XMTC cable, P/N X4(10). This cable can be used for distances up to 4000 ft (1200 m).

Table 1: GE 4-Wire XMTC Cable

Lead	Color	AWG	Terminal
+24 VDC Line	Red	22	TB1-1
24 VDC Return	Black	22	TB1-2
4-20 mA (+)	White	22	TB1-3
4-20 mA (-)	Green	22	TB1-4

If you are using your own cable to wire the XMTC, refer to *Table 2* below for the cable requirements.

Table 2: Non-GE 4-Wire XMTC Cable

Maximum Cable Length		Wire Size	
ft	m	AWG	mm ²
450	130	22	0.35
700	200	20	0.60
1,050	320	18	1.00
1,700	500	16	1.20
2,800	850	14	2.00
4,000	1,200	12	3.00

2.4.3 Cable Specifications (cont.)

Table 3 below shows the connections for the GE standard 3-wire RS232 cable (P/N 704-668), which is available with a male or female DB-9 or a DB-25 connector. This cable is available in standard lengths of 6 ft (2 m) and 12 ft (4 m).

Table 3: GE 3-Wire RS232 Cable

Lead	Color	AWG	Terminal
RX	Red	22	TB2-1
TX	White	22	TB2-2
GND	Green	22	TB2-3

Note: See *EIA-RS Serial Communications (document 916-054)* for detailed RS232 wiring instructions.

2.4.4 Wiring the Signal Connections

The XMTC power input, analog output, and RS232 connections are made to terminal blocks TB1 and TB2, which are accessed by removing the XMTC cover. See Figure 7 below for the location and pin designations for terminal blocks TB1 and TB2. Also refer to Appendix C, *Installation and Wiring Diagrams*.



CAUTION! Do not make any connections to unassigned or unused terminals.

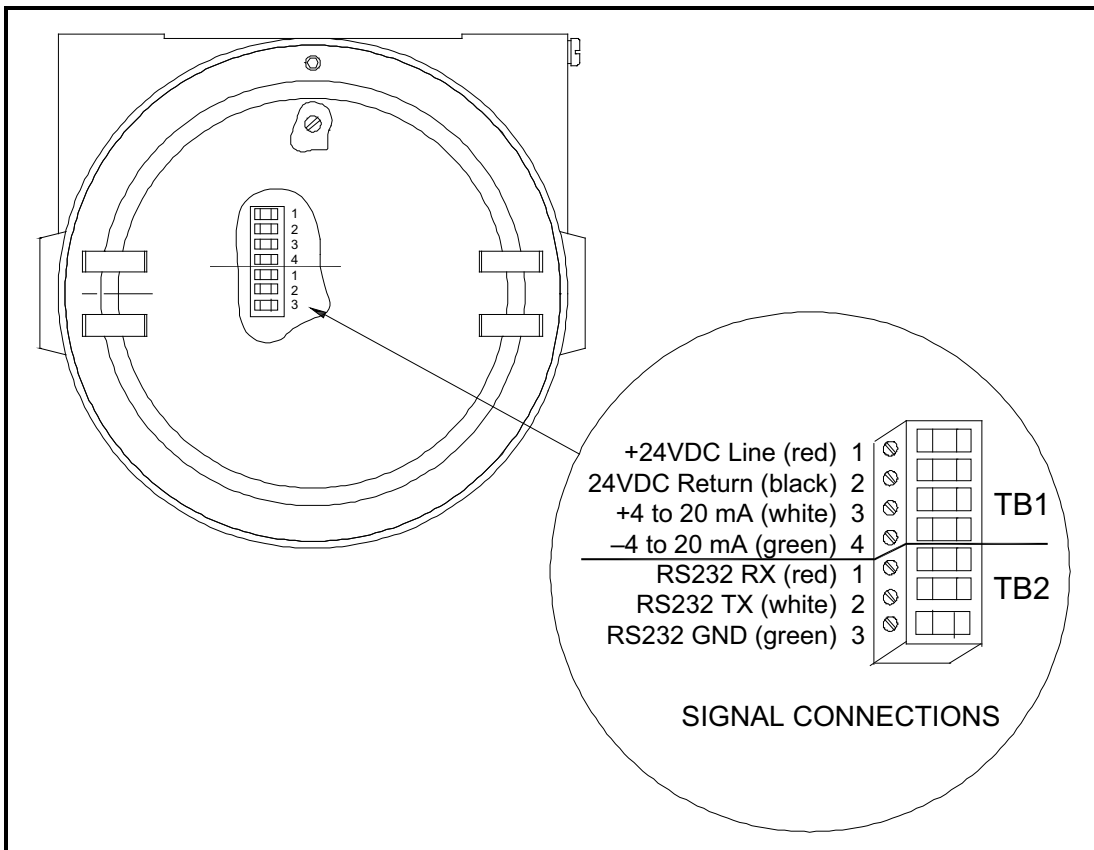

Figure 7: XMTC Signal Wiring Connections

2.4.4 Wiring the Signal Connections (cont.)

Use the following steps to make the proper wiring connections:



WARNING! Cable entries of an approved explosion-proof design are required. These must be installed according to the manufacturer's instructions. The choice of cable entry device may limit the overall installation category achieved.

1. Install the selected cable entry device, such as conduit or seal-off, in accordance with the manufacturer's instructions.

Note: *If installation of the cable entry device is only partially complete, GE recommends tagging the device to ensure the safety of subsequent users.*

2. Route the cable into the XMTC.
3. Unplug the TB1 and TB2 connectors by pulling them straight off the PCB, and loosen the screws on the sides of the connectors.
4. Connect the power leads:



CAUTION! Connecting the +24 VDC line (red) lead to any terminal except TB1-1 will damage the XMTC.

- a. Insert the 4-wire cable +24 VDC line (red) lead into pin TB1-1 and tighten the screw.
- b. Insert the 4-wire cable 24 VDC return (black) lead into pin TB1-2 and tighten the screw.
5. Connect the analog output leads:
 - a. Insert the 4-wire cable + 4-20 mA (white) lead into pin TB1-3 and tighten the screw.
 - b. Insert the 4-wire cable – 4-20 mA (green) lead into pin TB1-4 and tighten the screw.

IMPORTANT: *You can use either an RS232 serial port (discussed in Step 6) or an RS485 serial port (discussed in Step 7), but not both.*

6. Connect the RS232 serial port leads:
 - a. Insert the 3-wire cable RX (red) lead into pin TB2-1 and tighten the screw.
 - b. Insert the 3-wire cable TX (white) lead into pin TB2-2 and tighten the screw.
 - c. Insert the 3-wire cable GND (green) lead into pin TB2-3 and tighten the screw.

2.4.4 Wiring the Signal Connections (cont.)

7. Connect the RS485 serial port leads.
 - a. Locate the jumpers J7 and J8 on the main PCB, using *Figure 8* below as a guide. Move the jumpers from the left (RS232) side to the right (RS485) side.
 - b. Connect the other end of the cable to the RS485 converter, as shown in *Figure 8* below.

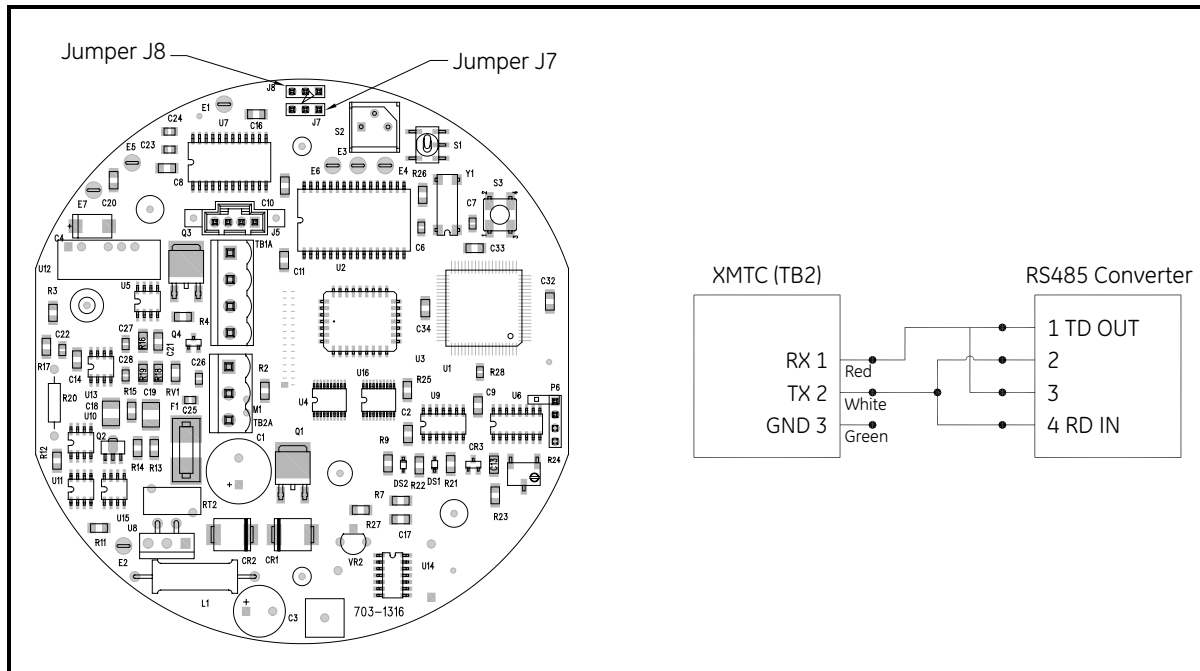

Figure 8: Jumper Locations and RS485 Connections

8. Carefully plug the TB1 and TB2 connectors back onto the PCB, and reinstall the cover on the XMTc.
9. Connect the other ends of the cables to the 24 VDC power supply, the 4-20 mA input of the display device, and the serial port of the computer or terminal (see the instruction manuals for those devices for details).

2.5 Connecting to Other Components

This section gives interconnection details for using other GE devices in conjunction with your XMTC.

2.5.1 PS5R-C24 Power Supply

The GE 24-Volt power supply converts 100/120/220/240 VAC to 24 VDC for use with the XMTC. *Figure 9* below shows an interconnection diagram for the XMTC and the PS5R-C24 power supply.

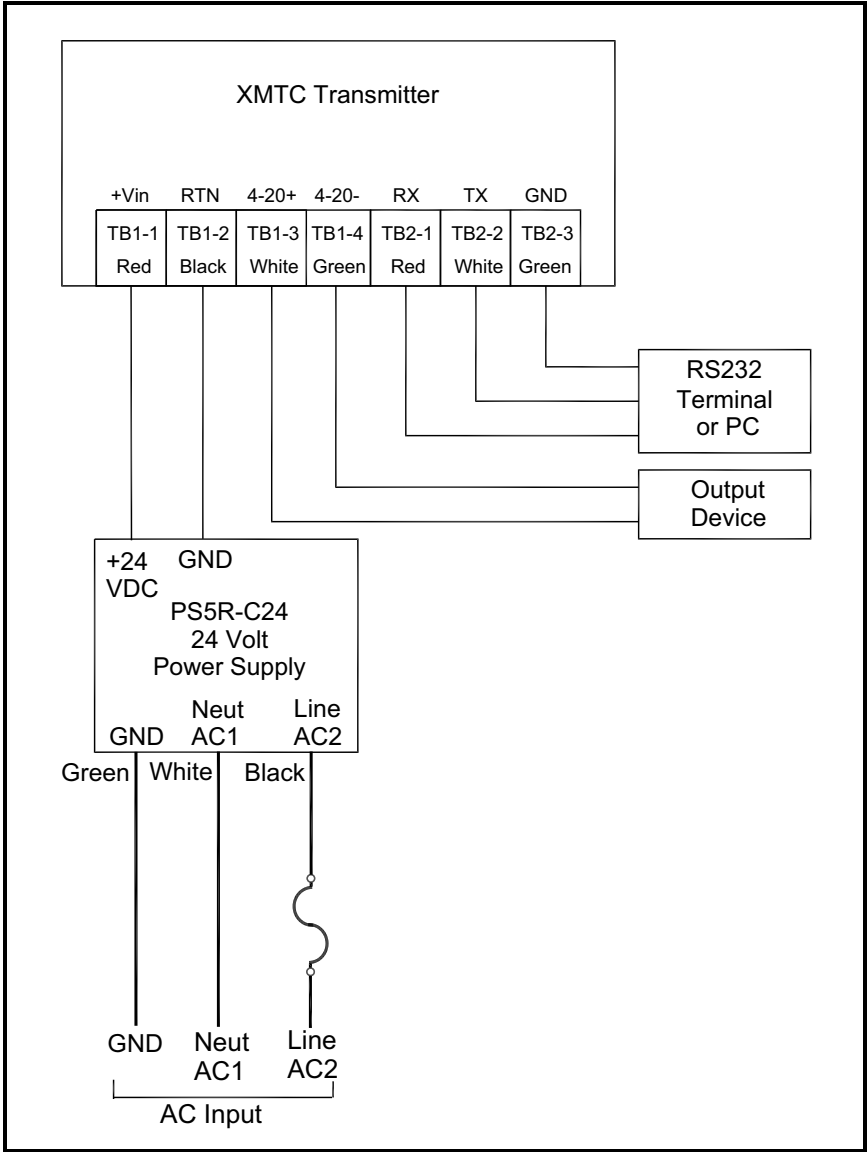

Figure 9: Interconnection Diagram

2.5.2 TMO2D Display

The GE TMO2D Display provides a two-line x 24 character back-lit LCD. It also features display and option programming, recorder outputs, alarm relays, and optional relays for driving sample system solenoids for automatic zero and span calibration of the XMTC. See *Figure 72 on page 83* for an interconnection diagram for the XMTC and the TMO2D, and refer to the *TMO2D User's Manual (910-084)* for details on its operation.

2.5.3 XDP Display

The XDP Explosion-proof Display Package provides an integral, voltage-stabilized 24 VDC power supply, a 3-digit display with adjustable 4-20 mA input range, two SPDT alarm relays rated for 1 A/250 VAC, and a 4-20 mA output that is isolated from the input and adjustable to a second independent range if required. The XDP is supplied in a weatherproof and explosion-proof enclosure that is rated for EEx d IIC T6 and IP66. See *Figure 72 on page 83* for interconnection diagrams for the XMTC and the MIS-1, MIS-2 and MMS-3 analyzers, and refer to the *XDP User's Manual (910-204)* for details on its operation.

2.5.4 Moisture Series Analyzers

The GE *Moisture Image Series 1 (MIS-1)* and *Moisture Monitor Series 3 (MMS-3)* analyzers accept inputs from a variety of sensors (including the XMTC) and offer new graphical and digital user interfaces, improved performance, and low range calibration. See *Figure 72 on page 83* for interconnection diagrams for the XMTC and the MIS-1 and MMS-3 analyzers, and refer to the appropriate *User's Manual* for details on operating the MIS-1 (910-108) or MMS-3 (910-110) analyzer.

Chapter 3. Operation and Programming

3.1 Introduction

This chapter provides information on operating the XMTC transmitter. The following topics are discussed:

- Powering up the XMTC
- Basic sample gas considerations
- Programming the XMTC with GE Instrument Data Manager (IDM™) software

If you have not already done so, please read Chapter 2, *Installation*, for details on mounting and wiring the XMTC and the sample system.

3.2 Powering Up the XMTC



WARNING! It is the responsibility of the user to ensure that all cable entry devices and covers are properly installed and secure prior to applying power to the XMTC.

The XMTC does not have a power switch. It begins operating as soon as it is connected to a 24 VDC power source. Because the XMTC is controlled at a constant 55°C (131°F) operating temperature, allow 30 minutes for the unit to warm up and reach temperature stability. During this time, you can establish a sample gas flow through the sample system.

3.3 Starting the Sample Gas

Open the necessary valves to establish a sample gas flow of 0.5 SCFH (250 cc/min) at atmospheric pressure. Make sure that nothing obstructs the flow of sample gas, thereby causing a pressure buildup in the sensing chamber. For proper operation, the XMTC should be vented to atmosphere.

Note: *Unless otherwise specified, the XMTC is factory calibrated at atmospheric pressure and 0.5 SCFH (250 cc/min) and should therefore be operated at atmospheric pressure. Operating the XMTC at any other pressure will necessitate a field calibration at that pressure in order to maintain accuracy. See Chapter 4, Calibration, for more information.*

If you are using the 4-Port (flowing reference gas) configuration, open the necessary valves to establish a reference gas flow of 0.5 SCFH (250 cc/min) at atmospheric pressure.

Note: *If desired, you can use a reference gas flow as low as 5 cc/min to conserve gas.*

3.4 Programming with IDM™

The XMTC is factory-programmed and ready for immediate use. However, if you wish to check or change the calibration, you can access the XMTC programming from your PC, using GE Instrument Data Manager (IDM) software. IDM also allows you to upload or download site files, display data, and log and view real-time data and diagnostic data in numeric, bar chart or line chart formats. For further information on the display and logging functions, refer to the *Instrument Data Manager User's Manual (910-185)*.

Note: *Be sure to install Instrument Data Manager on your PC before attempting to program the XMTC.*

3.5 The Edit Functions Menu

To access the XMTC calibration, you must open the *Edit Functions* menu in the Instrument window. See Chapter 5, *Using the Instrument Menu*, in the *Instrument Data Manager User's Manual* for more information on the Instrument Menu. The menu consists of the five commands shown in *Figure 10* below. To access a command, select it from the list of options.

Note: *While following the programming instructions, refer to Figure 51 on page 41 and Figure 52 on page 42.*

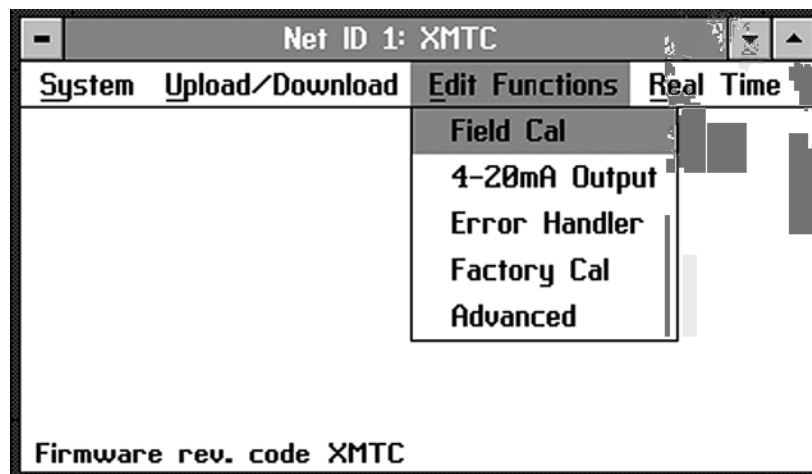

Figure 10: Edit Functions Menu

Three buttons appear on the right side of all menu windows: *Previous Item*, *Next Item/Enter*, and *Exit Page* (see *Figure 11* on page 21):

- Clicking on *Previous Item* returns you to the previous window (either the command menu or the previous parameter entered).
- *Next Item/Enter* confirms the selection or data entered, and either opens the next window or returns you to the command menu (depending on your position in the program).
- *Exit Page* returns you to the command menu.

3.6 Field Cal

When you select the *Field Cal* command, a window similar to the one in *Figure 11* below opens.

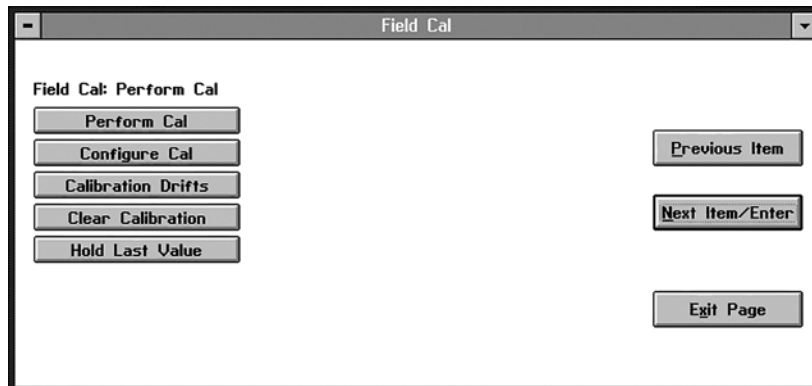

Figure 11: *Field Cal* Window

The *Field Cal* command offers five options:

- *Perform Cal* — enables you to calibrate the XMTC with IDM
- *Configure Cal* — enables you to set the calibration type and parameters
- *Calibration Drifts* — indicates drift percentages for the zero and span gases
- *Clear Calibration* — enables you to clear the last calibration
- *Hold Last Value* — causes the XMTC to hold the last value calibrated.

Clicking on any option opens that option, while clicking on *Next Item/Enter* opens the menu listed on the status line above the options.

3.6.1 Perform Cal

Click on *Perform Cal* to open a window similar to *Figure 12* below.

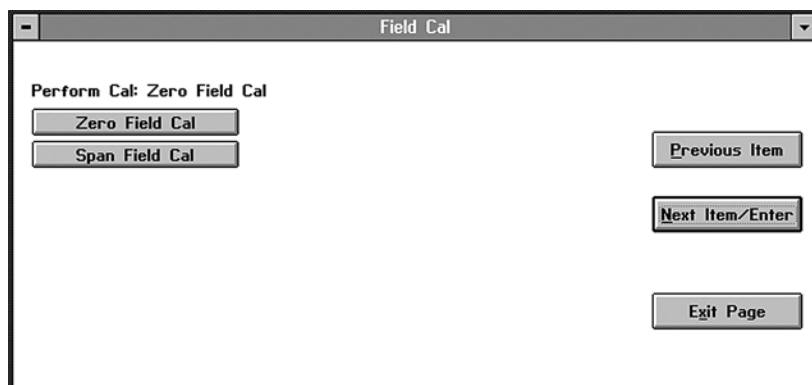

Figure 12: *Perform Cal* Window

3.6.1 Perform Cal (cont.)

Click on *Zero Field Cal* to calibrate the zero value, or on *Span Field Cal* to calibrate the span value. In either case, a window similar to *Figure 13* below opens.

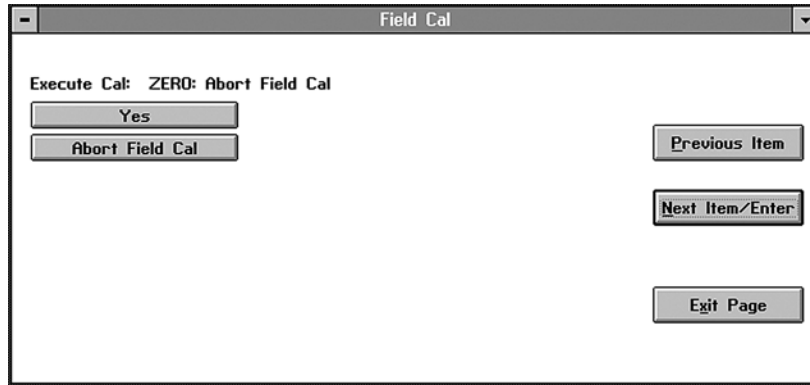

Figure 13: *Field Cal* Execution Window

Click *Yes* to calibrate, or *Abort Field Cal* to stop the calibration and return to the previous menu. The result of a completed calibration is shown in *Figure 14* below.

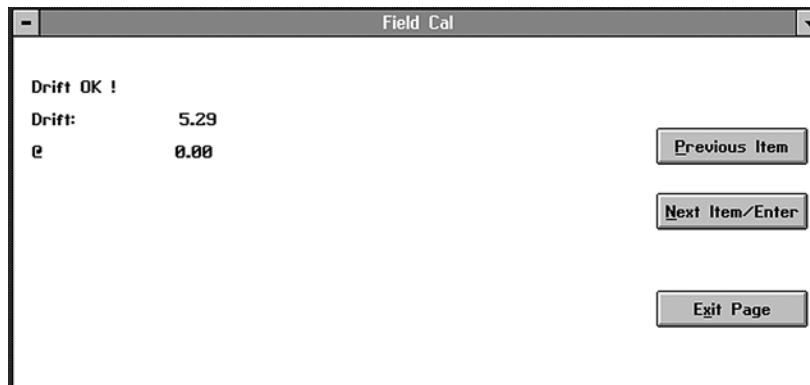

Figure 14: *Field Cal* Results Window

Click on *Previous Item* or on *Next Item/Enter* to return to the previous window, or on *Exit Page* to return to the Instrument Menu.

3.6.2 Configure Cal

The *Configure Cal* command enables you to change the field calibration type and parameters: the percentage of zero or span gas, delay time before or after, and maximum total drift and drift of calibration. When you click on *Configure Cal*, a window similar to *Figure 15* below opens. Clicking on any option opens the window for that option, while clicking on *Next Item/Enter* opens the menu listed on the status line above the options.

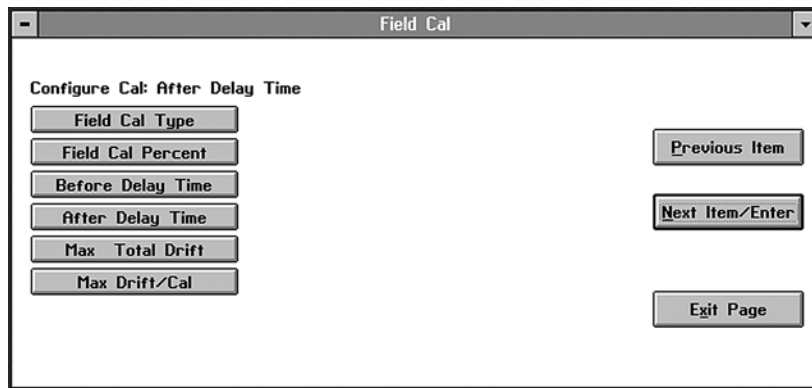

Figure 15: *Configure Cal* Window

3.6.2a Field Cal Type

The window for *Field Cal Type* is similar to *Figure 16* below.

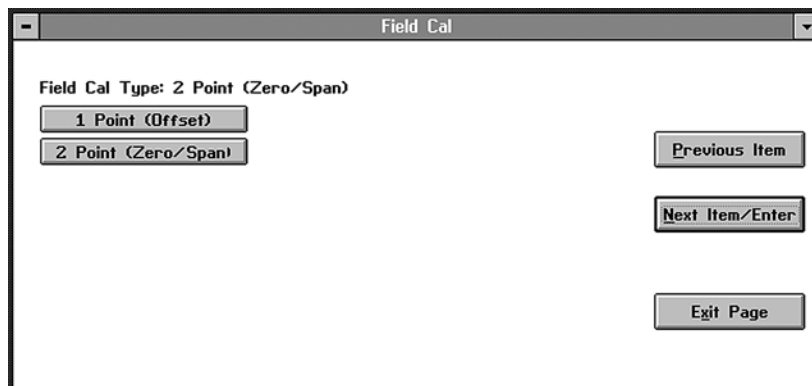

Figure 16: *Field Cal Type* Window

Click on *1 Point* to select 1-Point (offset, or 1-gas) calibration, or on *2-Point* to select 2-Point (zero/span, or 2-gas) calibration. Then, click on any button on the right to return to the *Configure Cal* window.

3.6.2b *Field Cal Percent*

The window for *Field Cal Percent* is similar to *Figure 17* below.

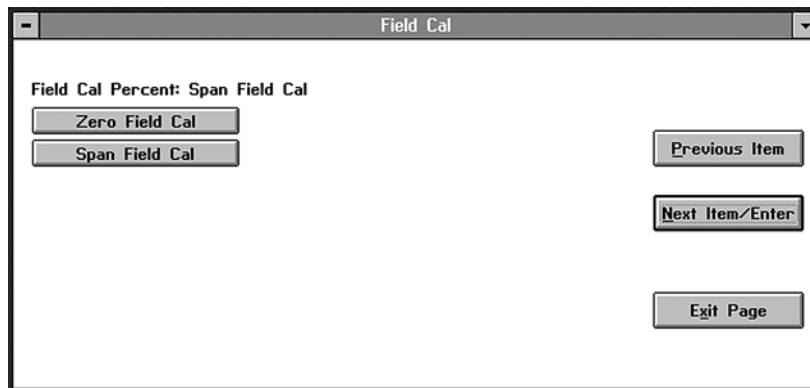

Figure 17: *Field Cal Percent* Window

Click on *Zero Field Cal* to enter the zero percentage, or on *Span Field Cal* to enter the span percentage. In either case, a window similar to *Figure 18* below opens.

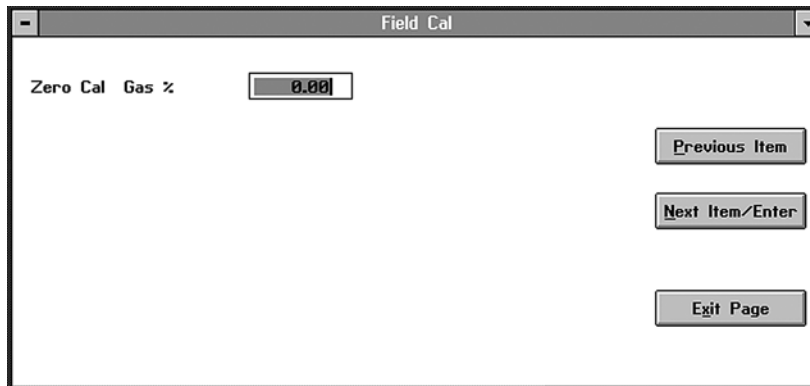

Figure 18: *Gas Percentage* Entry Window

Type the desired percentage in the text box, and click *Next Item/Enter* to confirm the entry. (Click *Previous Item* or *Exit Page* to close the window without changing the percentage.)

3.6.2c Before Delay Time and After Delay Time

The windows for both *Before Delay Time* and *After Delay Time* are similar to *Figure 19* below.

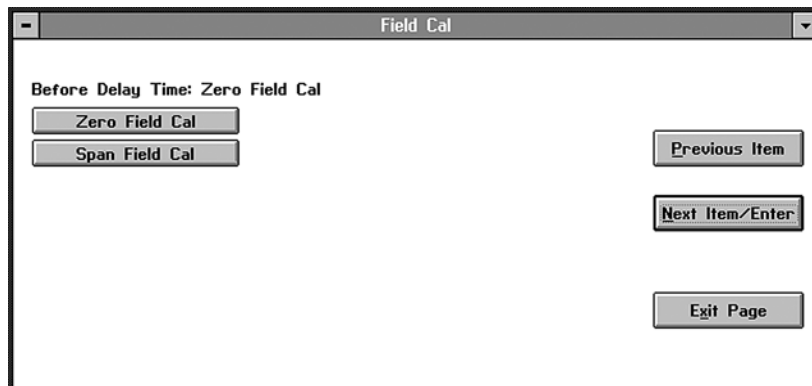

Figure 19: Before Delay Time Window

For either time, click on *Zero Field Cal* to enter the delay time for the zero calibration, or on *Span Field Cal* to enter the time for the span calibration. A window similar to *Figure 20* below opens.

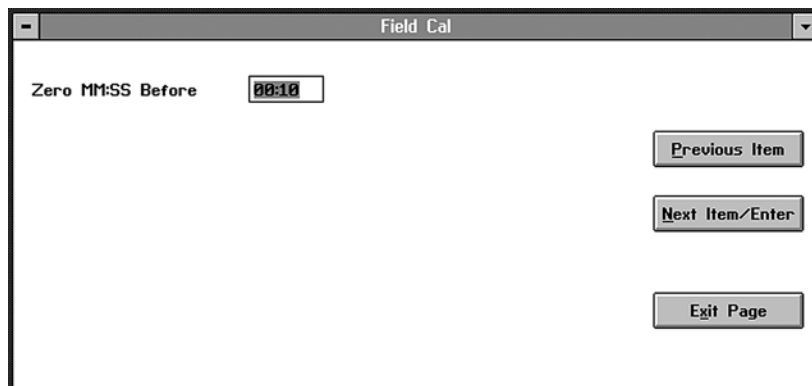

Figure 20: Delay Time Entry Window

Enter the desired number of minutes and seconds in the text box, and click *Next Item/Enter* to confirm the entry. (Click *Previous Item* or *Exit Page* to close the window without changing the percentage.) You are then returned to the *Configure Cal* window.

3.6.2d Max Total Drift and Max Drift/Cal

Max Total Drift is the maximum total drift allowable as a percentage of full scale, while *Max Drift/Cal* is the maximum drift allowable per calibration as a percentage of full scale. The windows for both *Max Total Drift* and *Max Drift/Cal* are similar to *Figure 21* below.

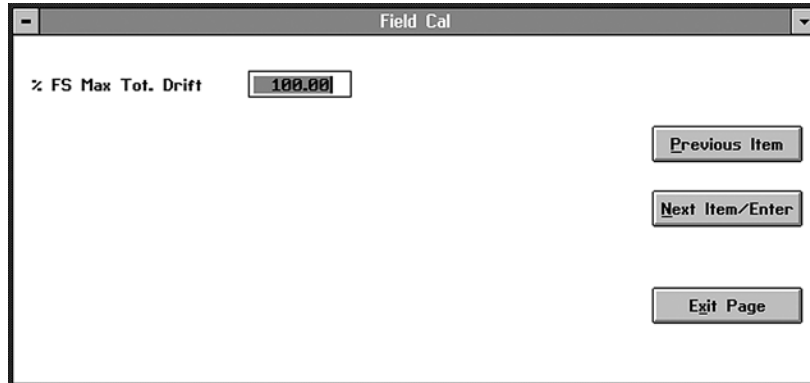

Figure 21: Max Total Drift Entry Window

Enter the desired percentage of full scale in the text box, and click *Next Item/Enter* to confirm the entry. (Click *Previous Item* or *Exit Page* to close the window without changing the percentage.) You are then returned to the *Configure Cal* window.

3.6.3 Calibration Drifts

The *Calibration Drifts* command enables you to view the drift of both zero and span gases since the last calibration. A window similar to *Figure 22* below opens.

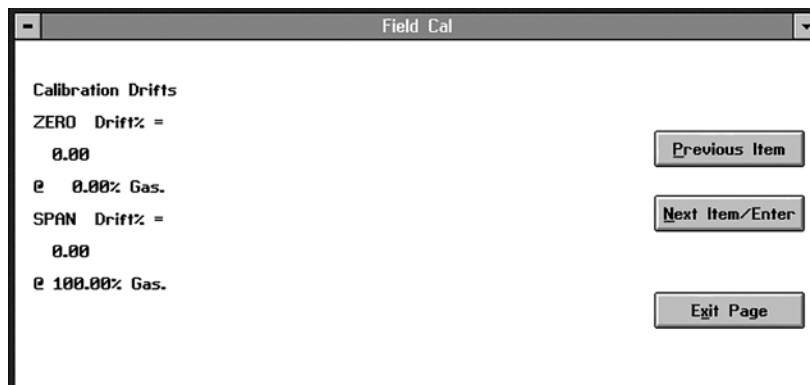

Figure 22: Calibration Drifts Window

Click on any button to return to the *Field Cal* window.

3.6.4 Clear Calibration

The window for the *Clear Calibration* command is similar to *Figure 23* below.

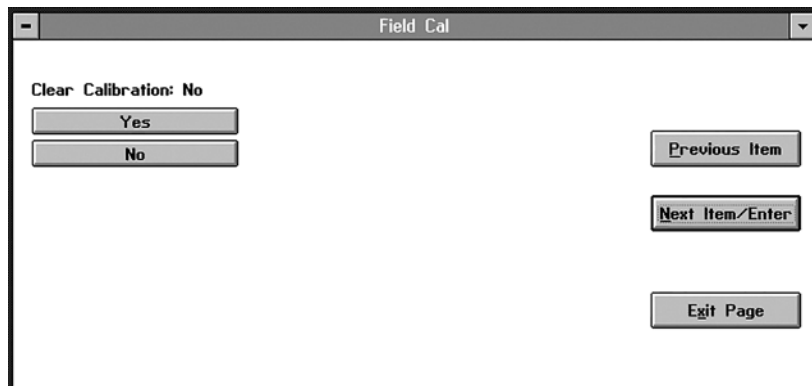

Figure 23: Clear Calibration Window

Click on *Yes* to clear the most recent calibration, or on *No*, *Previous Item* or *Exit Page* to close the window without clearing the calibration. If you click on *Yes* and then on *Next Item/Enter*, a window similar to *Figure 24* below opens.

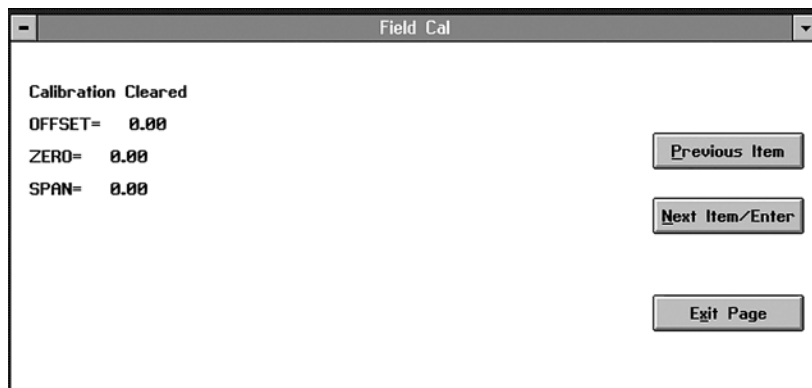

Figure 24: Typical Cleared Calibration Window

Click on *Previous Item* to return to the *Clear Calibration* window, or on *Next Item/Enter* or *Exit Page* to return to the *Field Cal* window.

3.6.5 Hold Last Value

Besides performing a calibration or configuring values, you can program the XMTC to hold the last calibrated value. From the *Field Cal* window (see *Figure 11* on page 21), click on *Hold Last Value*. The window remains the same, except that the button changes to *Disable Hold Last*. Click *Next Item/Enter* to confirm the entry, or *Previous Item* or *Exit Page* to close the window without changing the value.

3.7 4-20 mA Output

The *4-20 mA Output* command enables you to modify the output that the XMTC sends to an external device such as a recorder or digital multimeter. When you click on the *4-20 mA Output* command from the *Edit Functions* menu (Figure 10 on page 20), a window similar to Figure 25 below opens. Clicking on any option opens the window for that option, while clicking on *Next Item/Enter* opens the menu listed on the status line above the options.

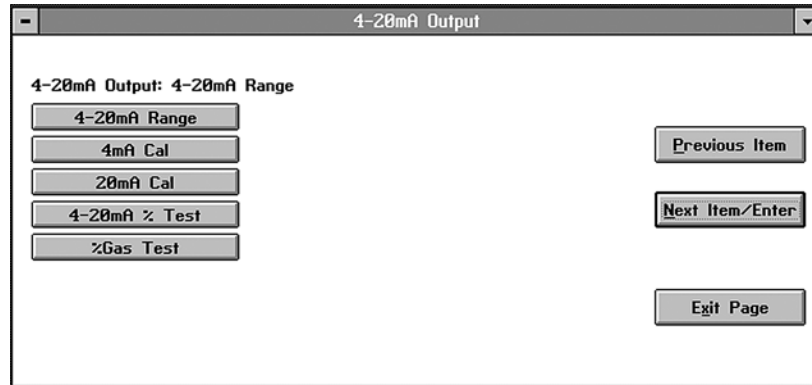

Figure 25: 4-20 mA Output Window

3.7.1 4-20 mA Range

The window for *4-20 mA Range* is similar to Figure 26 below.

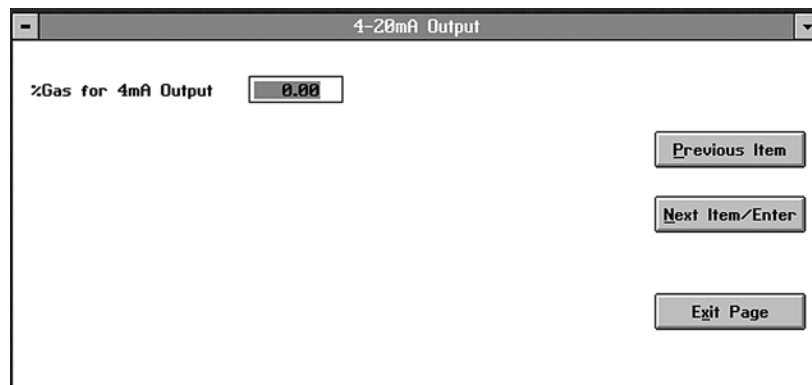

Figure 26: 4 mA Output Gas Percentage Window

Enter the desired percentage of gas for the 4 mA output in the text box. Clicking on *Next Item/Enter* opens the window for the 20 mA output, shown in Figure 27 on page 29.

3.7.1 4-20 mA Range (cont.)

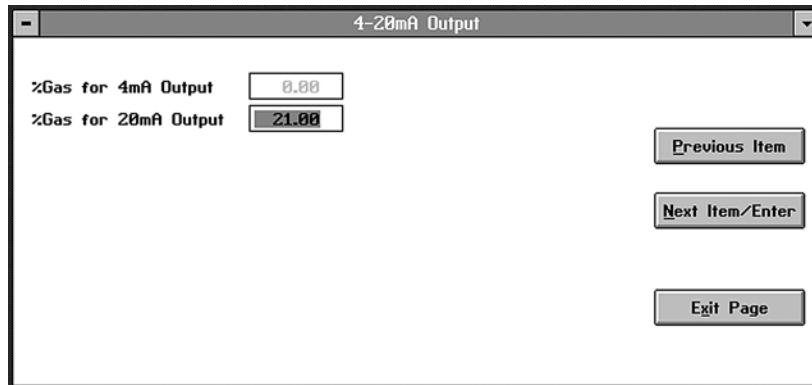

Figure 27: 20 mA Output Gas Percentage Window

Enter the desired percentage of gas for the 20 mA output, and click *Next Item/Enter* to confirm the entry. The next prompt is: “Clamp 4-20 mA Output?” Click on either *No* or *Yes* from the drop-down menu. A clamped reading never exceeds the programmed 4-20 mA output range, while a reading that is not clamped can display measurements outside the programmed range. (Click *Previous Item* to return to the previous parameter or on *Exit Page* to close the window without changing the percentage.) You are then returned to the *4-20 mA Output* window.

3.7.2 4 and 20 mA Cal

To calibrate the 4 and 20 mA output signals, click on the *4 mA Cal* and *20 mA Cal* commands respectively. In either case, a window similar to *Figure 28* below opens.

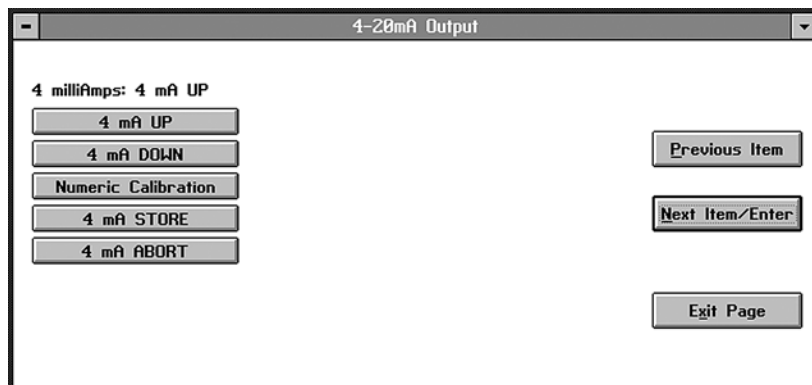

Figure 28: 4 mA Signal Calibration Window

Clicking on the *UP* command increases the signal incrementally, while clicking on the *DOWN* command decreases it incrementally. Clicking on *Numeric Calibration* opens a window similar to the one shown in *Figure 29* on page 30.

3.7.2 4 and 20 mA Cal (cont.)

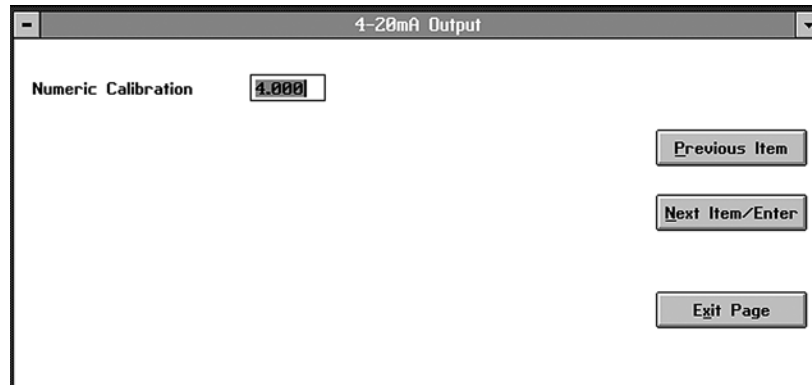

Figure 29: Numeric Calibration Window

Enter the desired number in the text box and click on *Next Item/Enter*. (Click on *Previous Item* or *Exit Page* to close the window without changing the signal.) You are then returned to the previous window. After you have calibrated the desired input signal, click on *STORE* to save the entry, and on *Next Item/Enter* to confirm it. If the signal is not satisfactory, click on *ABORT*. (Click *Previous Item* or *Exit Page* to close the window without changing the signal.) You are then returned to the *4-20 mA Output* window (see *Figure 25 on page 28*).

3.7.3 4-20 mA % Test

The window for *4-20 mA % Test* is similar to *Figure 30* below.

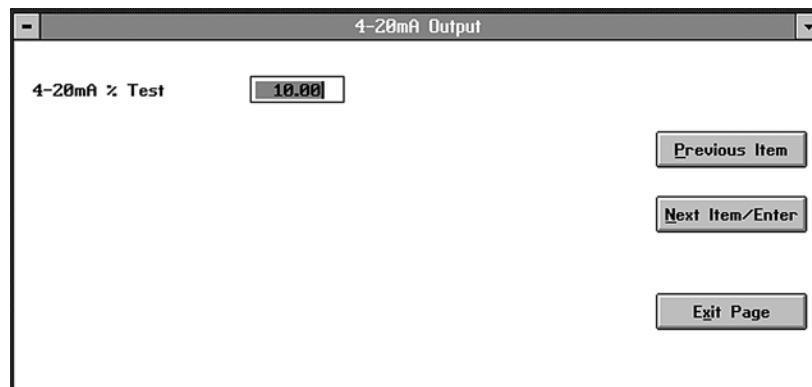

Figure 30: 4-20 mA% Test Window

Enter the desired percentage, and click on *Next Item/Enter* to confirm the entry. A second text box opens, enabling you to test at another percentage if desired. Repeat the procedure until you have entered all desired test values. Then click *Exit Page* to close the window.

3.7.4 % Gas Test

The window for % Gas Test is similar to *Figure 31* below.

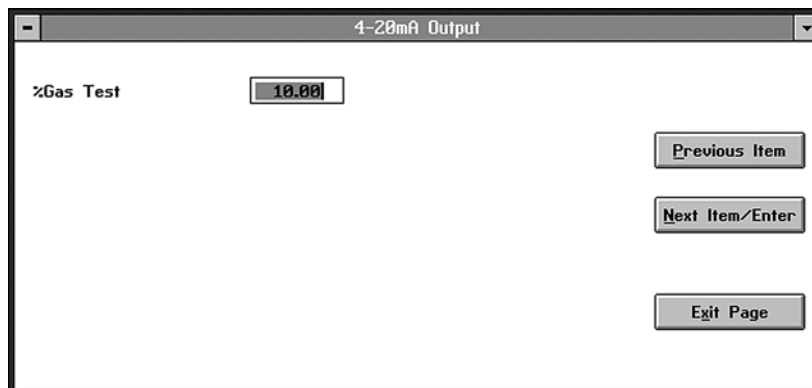

Figure 31: % Gas Test Window

Enter the desired percentage, and click on *Next Item/Enter* to confirm the entry. A second text box opens, enabling you to test at another percentage if desired. Repeat the procedure until you have entered all desired values. Then click *Exit Page* to close the window.

3.8 Error Handler

The *Error Handler* command allows you to enable or disable error handling for specific error conditions for the XMTC. When you click on the *Error Handler* command from the *Edit Functions* menu (*Figure 10 on page 20*), a window similar to *Figure 32* below opens. Clicking on any option opens the window for that option.

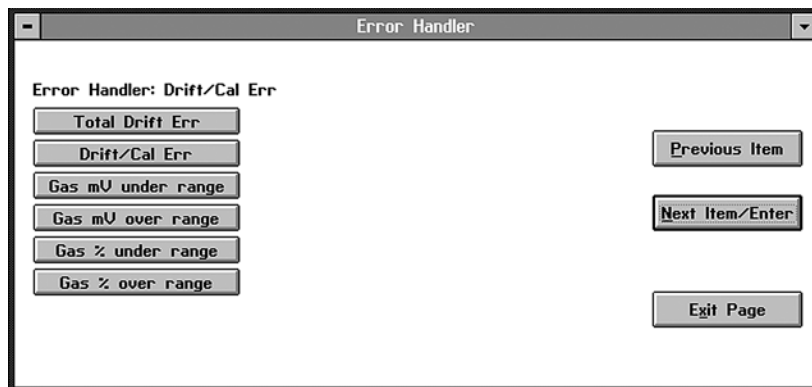

Figure 32: Error Handler Window

3.8.1 Total Drift Error

The *Total Drift Error* option lets you enable or disable error handling for Total Drift Error. The window is similar to *Figure 33* below.

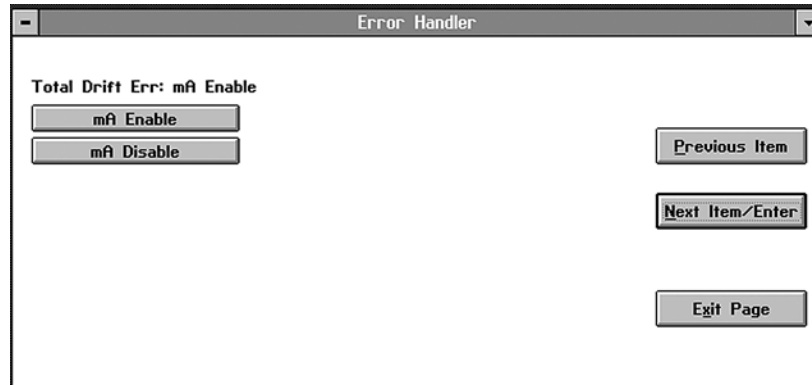

Figure 33: Total Drift Error Window

If you click on *mA Enable*, a window similar to *Figure 34* below opens.

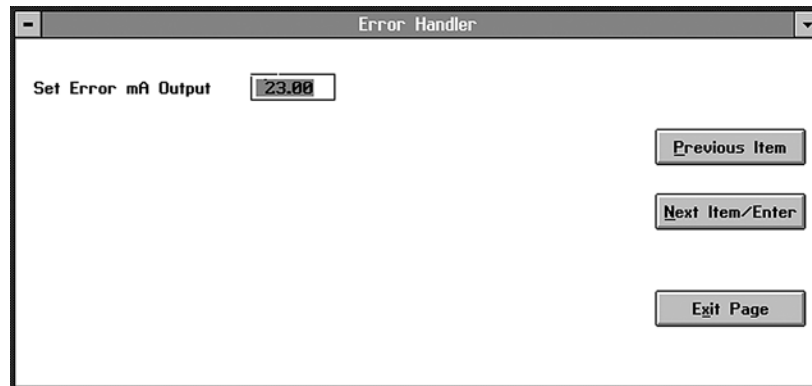

Figure 34: Error mA Output Window

Enter the desired error mA output in the text box, and click on *Next Item/Enter* to confirm the entry. You are then asked for confirmation, as shown in *Figure 35* on page 33.

3.8.1 Total Drift Error (cont.)

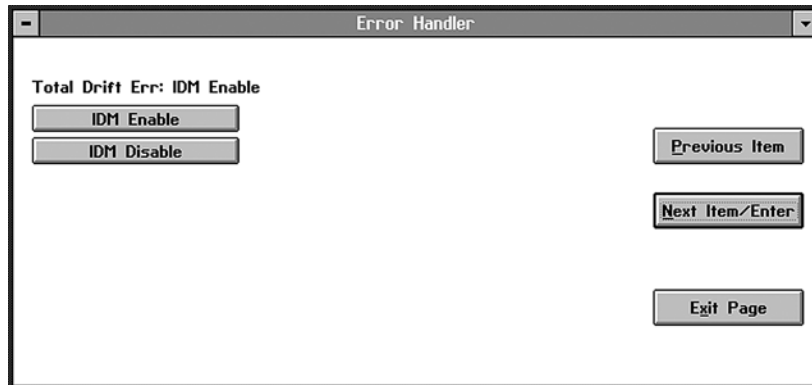

Figure 35: IDM Enable/Disable Window

Click on *IDM Enable* to enable drift error. (Click *Previous Item* or *Exit Page* to close the window without changing the output.) However, if you click on *mA Disable*, you are also asked for confirmation. Click on *IDM Disable* to disable the drift error. You are then returned to the *Error Handler* window.

3.8.2 Drift/Cal Error

The *DriftCal Error* option lets you enable or disable error handling for DriftCal, generated when an error occurs during calibration. The window is similar to *Figure 36* below.

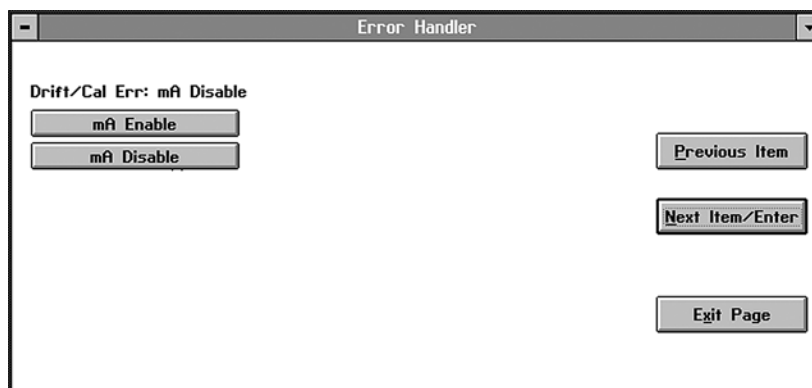

Figure 36: DriftCal Error Window

If you click on *mA Enable*, the window displays a text box similar to that in *Figure 34* on page 32. Enter the desired error mA output in the text box, and click on *Next Item/Enter* to confirm the entry. You are then asked for confirmation, as shown in a window similar to *Figure 35*. Click on *IDM Enable* to enable drift error. (Click *Previous Item* or *Exit Page* to close the window without changing the output.) However, if you click on *mA Disable*, you are also asked for confirmation. Click on *IDM Disable* to disable the drift error. You are then returned to the *Error Handler* window.

3.8.3 Gas mV Under/Over Range

The *Gas mV Under Range* and *Gas mV Over Range* options let you enable or disable error handling for the main gas signal. The window is similar to *Figure 37* below.

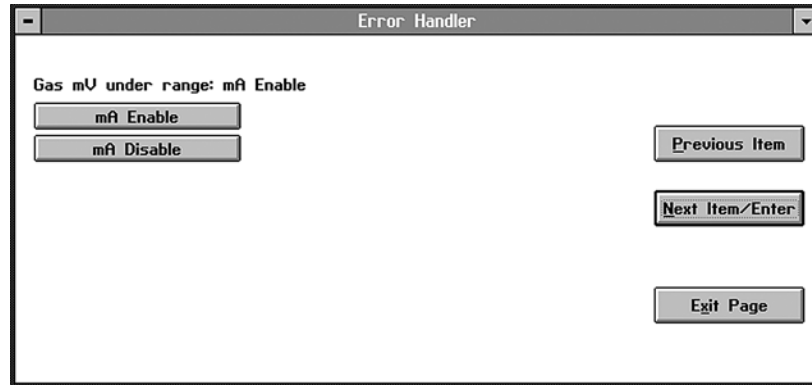

Figure 37: Gas mV Under Range Window

If you click on *mA Enable*, the window displays a text box. Enter the desired error mA output in the text box, and click on *Next Item/Enter* to confirm the entry. You are then asked for confirmation. Click on *IDM Enable* to enable the under or over-range error. (Click *Previous Item* or *Exit Page* to close the window without changing the output.) However, if you click on *mA Disable*, you must confirm the choice in a second window. Click on *IDM Disable* to disable the under or over-range error. You are then returned to the *Error Handler* window.

3.8.4 Gas % Under/Over Range

The *Gas % Under Range* and *Gas % Over Range* options let you enable or disable error handling for the main gas percentage. The window is similar to *Figure 38* below.

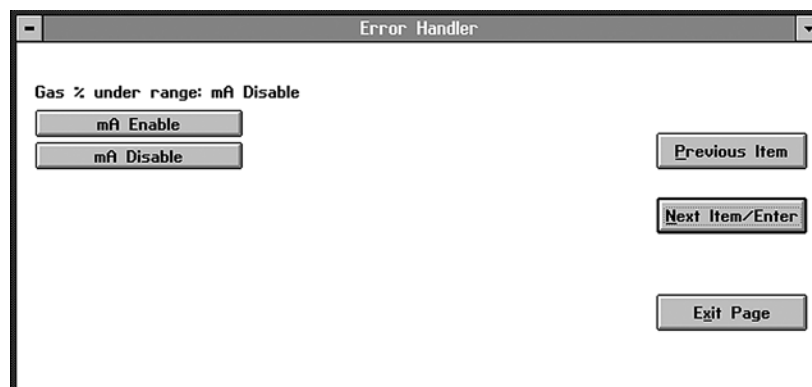

Figure 38: Gas % Under Range Window

If you click on *mA Enable*, the window displays a text box. Enter the desired error mA output in the text box, and click on *Next Item/Enter* to confirm the entry. Then click on *IDM Enable* to enable the under or over-range error. (Click *Previous Item* or *Exit Page* to close the window without changing the output.) However, if you click on *mA Disable*, you must confirm the choice in a second window. Click on *IDM Disable* to disable the under or over-range error. You are then returned to the *Error Handler* window.

3.9 Factory Cal

The XMTC comes completely preprogrammed from the factory for your particular application. Should it become necessary to reprogram the meter, you can use the *Factory Cal* option.

IMPORTANT: *Do not use the Factory Cal option without referring to the Calibration Data Sheet enclosed with your XMTC. Varying from the parameters on the sheet can result in problems with the XMTC and other equipment.*

From the *Edit Functions* menu (shown in *Figure 10 on page 20*), click on the *Factory Cal* option. A window similar to *Figure 39* below opens.

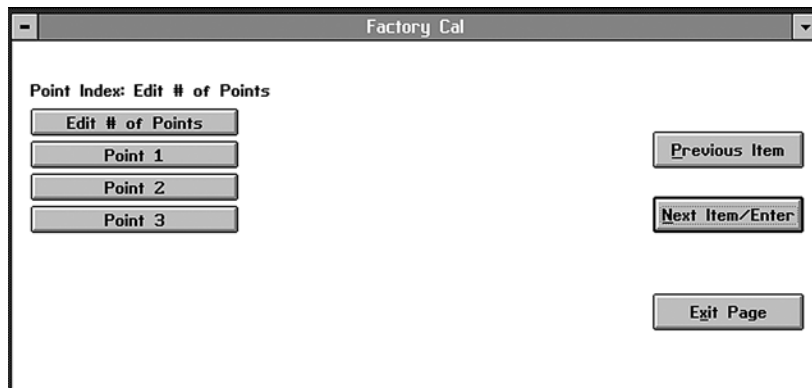

Figure 39: *Factory Cal* Window

The option permits you to edit the number of points and the value of each individual point.

3.9.1 Edit # of Points

To edit the number of available points, click on *Edit # of Points*. A window similar to *Figure 40* below opens.

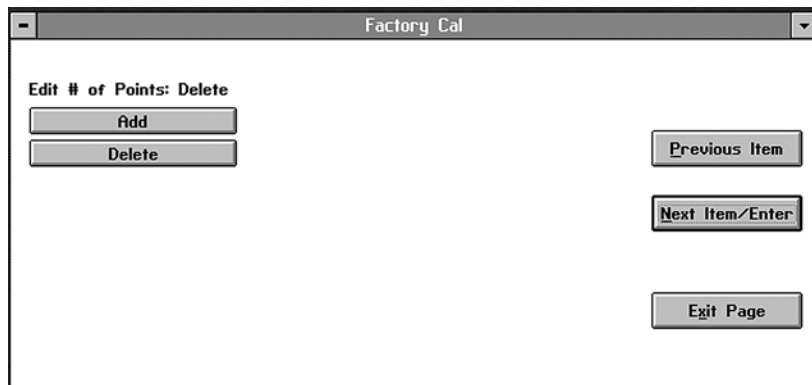
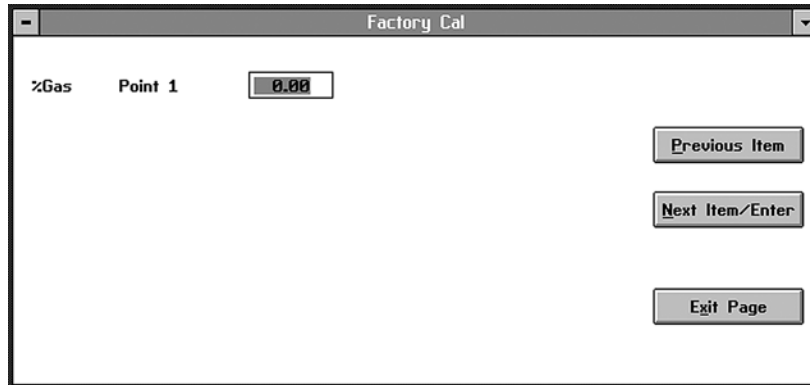

Figure 40: *Edit # of Points* Window

Click on *Add* once for each point you wish to add, or on *Delete* once for each point you wish to remove. Then click on *Next Item/Enter* to confirm the entry. (Click *Previous Item* or *Exit Page* to close the window without changing the number of points.) You are then returned to the *Factory Cal* window, which displays the new number of points.

3.9.2 Edit Point X

To edit the value for any particular point, click on that point in the *Factory Cal* window. A window similar to *Figure 41* below opens.



The screenshot shows a window titled "Factory Cal" with a dropdown arrow on the right. Inside the window, there is a label "%Gas" followed by "Point 1" and a text input box containing the value "0.00". To the right of the input box are three buttons: "Previous Item", "Next Item/Enter", and "Exit Page".

Figure 41: Point Editing Window

Enter the gas percentage in the text box, and click on *Next Item/Enter* to confirm the entry. (Click *Previous Item* or *Exit Page* to close the window without changing the value.) Then, enter the next value, as shown in *Figure 42* below.

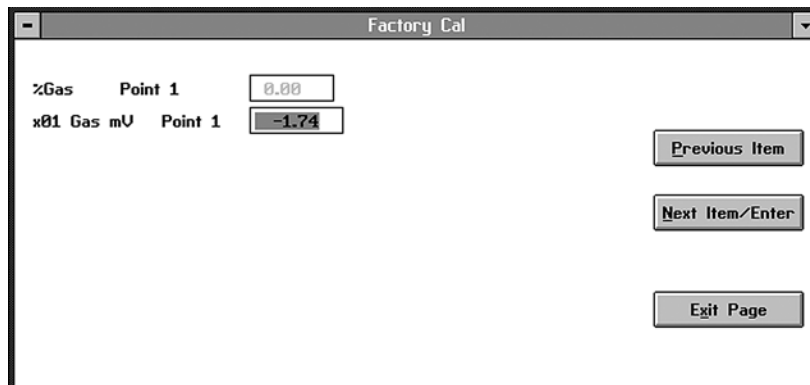

The screenshot shows the same "Factory Cal" window. The "%Gas" input box now contains "0.00". Below it, there is a new label "x01 Gas mV" followed by "Point 1" and a text input box containing the value "-1.74". The "Next Item/Enter" button is now highlighted, indicating it is the active element.

Figure 42: Additional Values for Point 1

Enter the x01 and x10 *Gas mV* values, and click on *Next Item/Enter* after each entry. After you have completed entering values, you are returned to the *Factory Cal* window.

3.10 The Advanced Option

IMPORTANT: Access to this menu is password-protected. Your assigned default **password = 2719**.

The final option on the *Edit Functions* menu is *Advanced*, an option that allows you to choose between *Fast Response* and *Language* response. In addition, you can add or change the meter identification number.

Note: For other available commands in the *Advanced* Option, refer to Appendix D.

From the *Edit Functions* menu (Figure 10 on page 20), click on *Advanced* to open a window similar to Figure 43 below. Then, enter your password.



Figure 43: Password Window

After you have entered the password, an *Advanced* window similar to Figure 44 below opens.

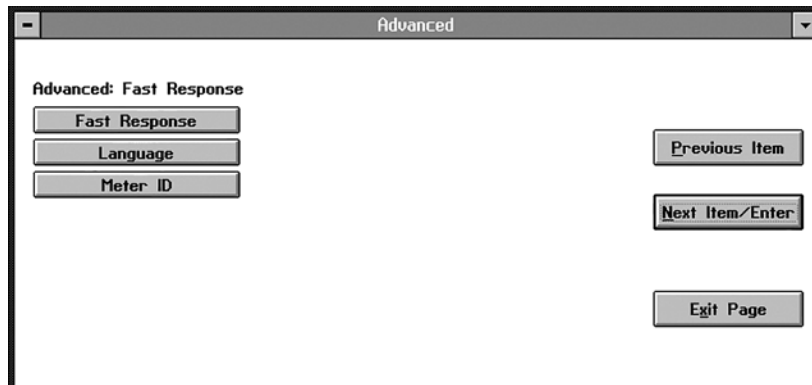

Figure 44: Advanced Window

Fast Response is software-enhanced response for faster performance under certain conditions, while *Language* response enables you to upload data to or download data from a PC. *Meter ID* enables you to enter or change a meter network identification number. Click on the desired command. (Click *Previous Item* or *Exit Page* to close the window without entering any commands.)

3.10.1 Fast Response

If you click on *Fast Response*, confirm the choice to open a window similar to *Figure 45* below.

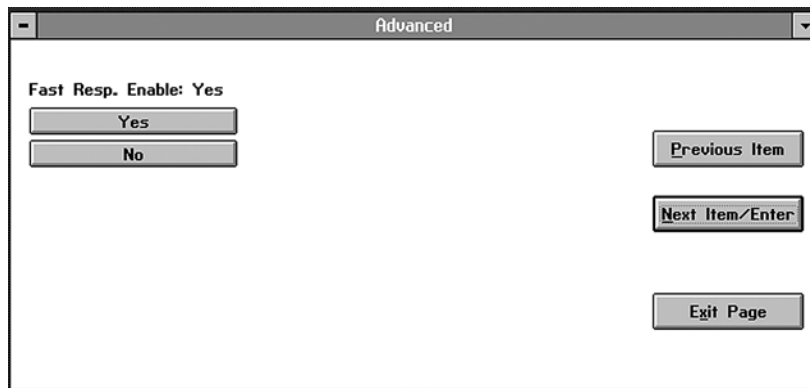

Figure 45: *Fast Response* Confirmation Window

Click *Yes* to enable *Fast Response*. In the series of three text boxes that follow, enter values for the *Fast Tau up*, *Fast Tau down*, and *Fast Threshold % FS* parameters. Then, click on *Next Item/Enter* to confirm the entry and open the next window.

IMPORTANT: Do not change the default values for these parameters without consulting the factory.

3.10.2 Language

If you click on *Language*, a window similar to *Figure 46* below opens.

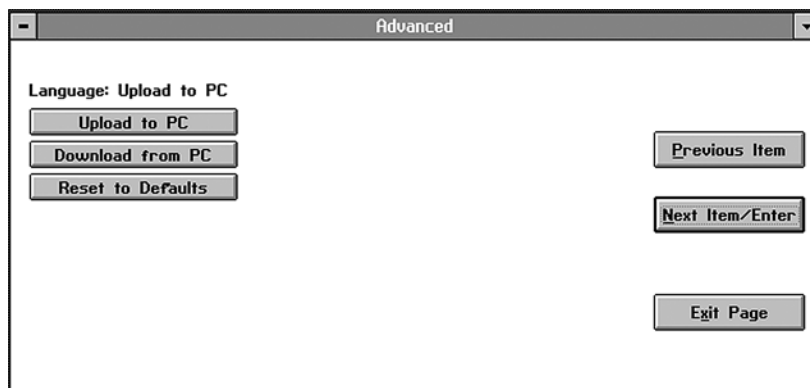

Figure 46: *Language* Window

3.10.2 Language (cont.)

If you click on *Upload to PC*, you are prompted to create a file, as shown in *Figure 47* below.

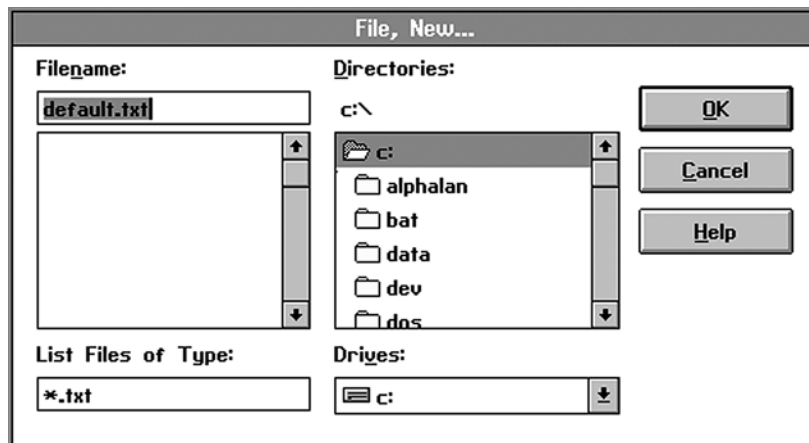

Figure 47: Creating a Data File

If you click on *Download from PC*, you are asked for a file name, as shown in *Figure 48* below.

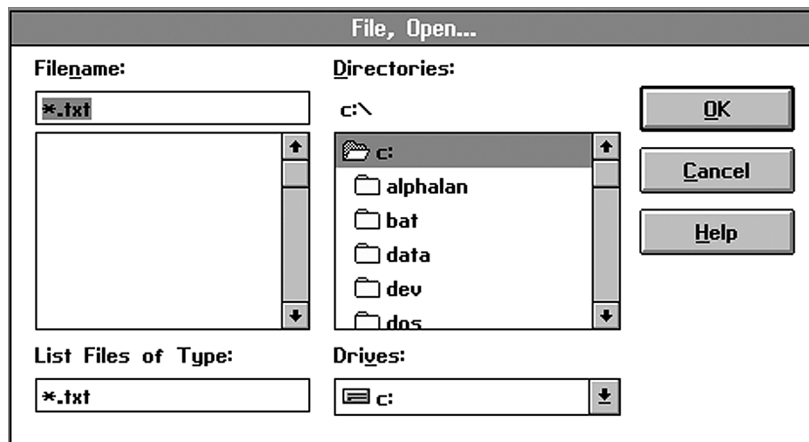

Figure 48: Downloading a Data File

However, if you click on *Reset to Defaults*, the status is displayed in the *Language* window. Click on *Next Item/Enter* to confirm the entry. (Click *Previous Item* or *Exit Page* to close the window without changing the status.)

3.10.3 Meter ID

The Meter ID window is similar to *Figure 49* below.

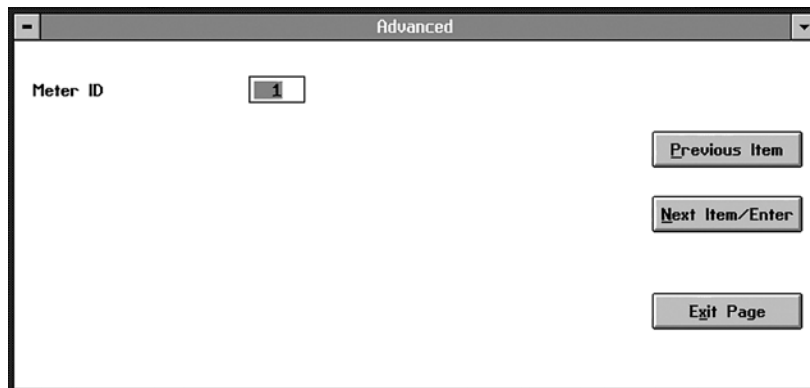

Figure 49: Meter ID Window

Either leave the existing number without change, or enter a new meter ID number. In either case, click *Next Item/Enter* to confirm the entry. (Click *Previous Item* or *Exit Page* to close the window without changing the number.) If you have changed an existing ID number, a window similar to *Figure 50* below opens.

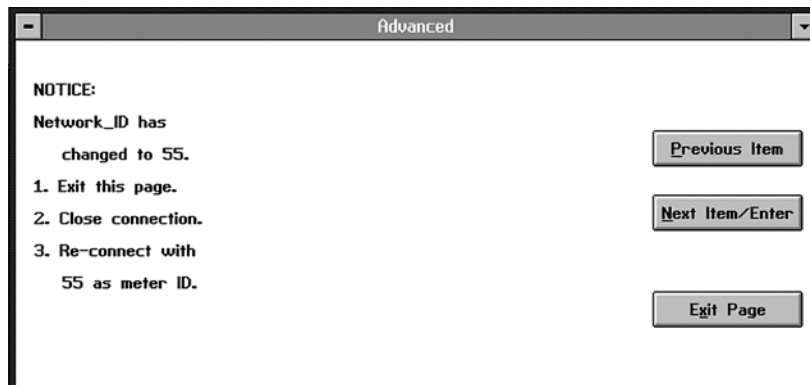

Figure 50: Revised Meter ID Window

IMPORTANT: *After you have entered a new ID number, you cannot reverse the change. You must exit the page, close the connection, and reconnect the meter using the new number.*

Click on *Next Item/Enter* or *Exit Page* to return to the *Advanced* window.

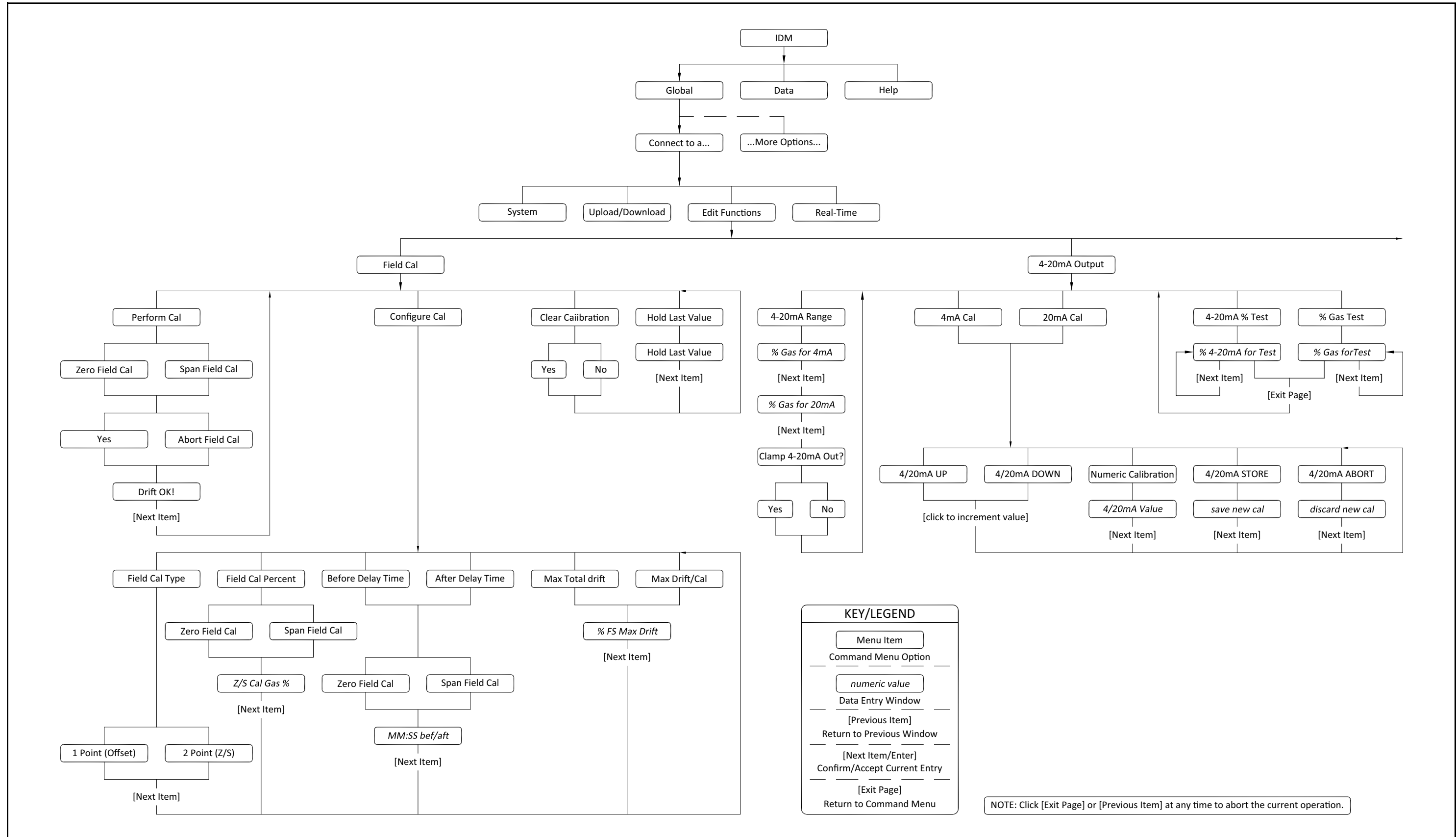

Figure 51: Field Cal and 4-20mA Output Menu Map

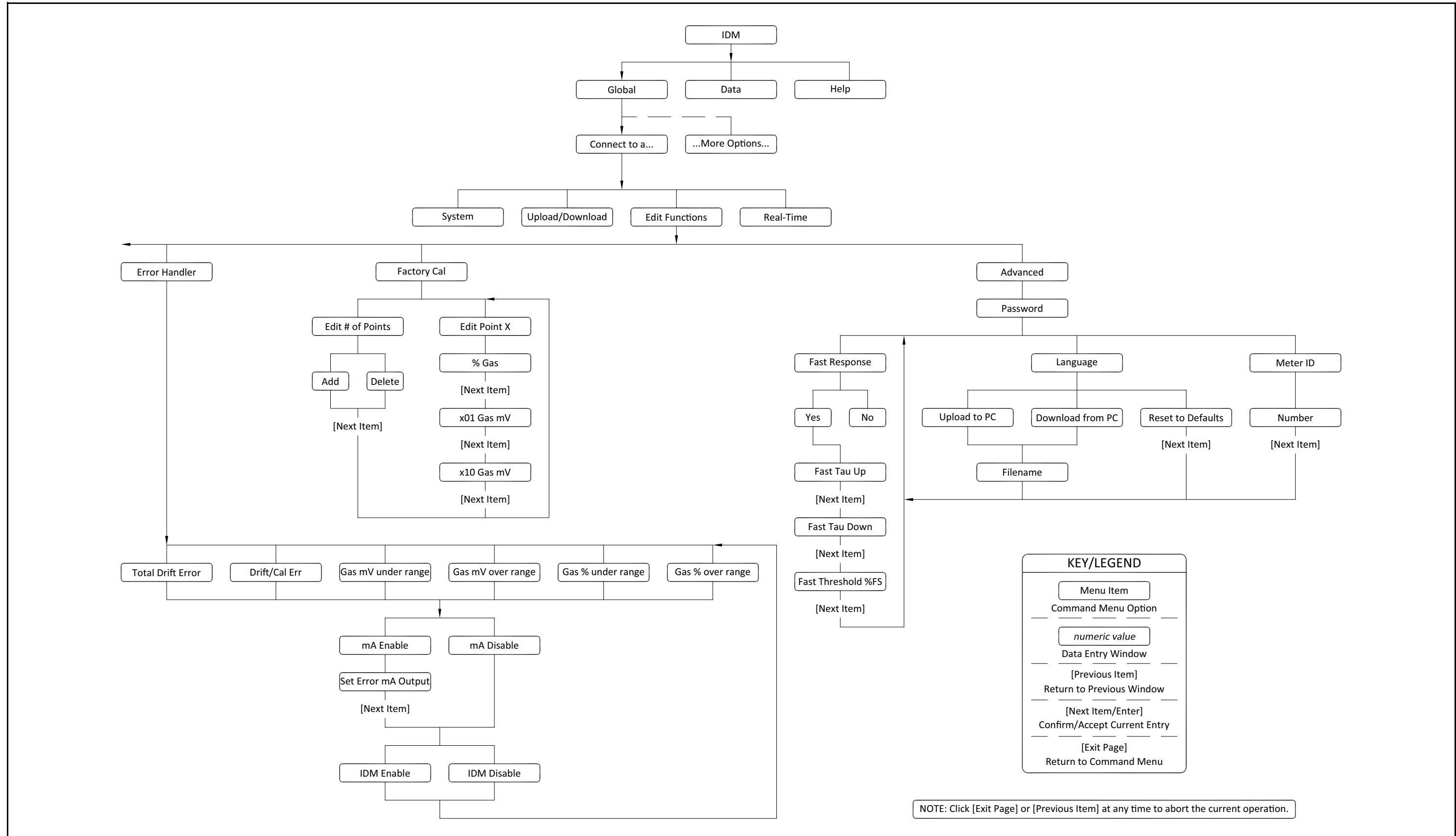

Figure 52: Error Handler, Factory Cal and Advanced Menu Map

Chapter 4. Calibration

4.1 Introduction

This chapter provides information on calibrating the XMTC in the field using zero, span, and reference gases. The following topics are discussed:

- General considerations for calibration at the factory and in the field
- What you will need before you begin calibrating
- Getting the XMTC ready and locating the adjustment potentiometers
- Calibrating the 2-Port (sealed reference gas) XMTC with zero and span gases
- Calibrating the 4-Port (flowing reference gas) XMTC with zero, span, and reference gases

4.2 Gas Ranges and Types

The XMTC was calibrated at the factory for the range and gas mixture specified at the time of purchase. The following standard ranges and gases are provided:

Ranges:	0-2%	Gases:	H ₂ in N ₂
	0-5%		He in Air
	0-10%		He in N ₂
	0-25%		CH ₄ in CO ₂ (minimum range 0-10% CH ₄)
	0-50%		CO ₂ in Air (minimum range 0-20% CO ₂)
	0-100%		CO ₂ in N ₂ (minimum range 0-20% CO ₂)
	50-100%		
	80-100%		
	90-100%		
	95-100%		
	98-100%		

Note: *Calibrations can be performed for special ranges and gases upon request.*

The XMTC requires recalibration every 2 to 6 months, depending on the application. The exact calibration interval will depend on such factors as: components of the binary gas mixture, desired accuracy, range, and cleanliness of the sample gas. You can recalibrate the XMTC for the same range and binary gas mixture as the previous calibration using just the zero and span adjustments.

4.3 Required Equipment and Materials



WARNING! The calibration procedure described in this section requires the use of specialized apparatus and should be performed only by properly trained personnel.

To calibrate the XMTC, you will need the following equipment and materials:

- XMTC Calibration Sheet
- +24 VDC, 1.2 A power supply (system power, if unit is installed in a system)
- Zero gas
- Span gas
- Reference gas (for the 4-Port version - the reference gas is usually the same as the span gas.)
- Sample system or individual components (e.g. flow meter, needle valve, pressure regulator) for connecting zero and span gases and controlling pressure and flow rates

Note: *The accuracy of the calibration will only be as accurate as the composition accuracy of the zero and span gases.*



WARNING! Do not use explosive gas mixtures to calibrate the XMTC.

4.4 Preparing the Transmitter for Calibration

Complete the following steps before connecting and adjusting the zero, span, and reference gases:

- 1. Allow 30 minutes after power is turned on for the XMTC to reach temperature stability.
- 2. Loosen the set screw that locks the XMTC cover in place, and unscrew the cover (see *Figure 53* below).

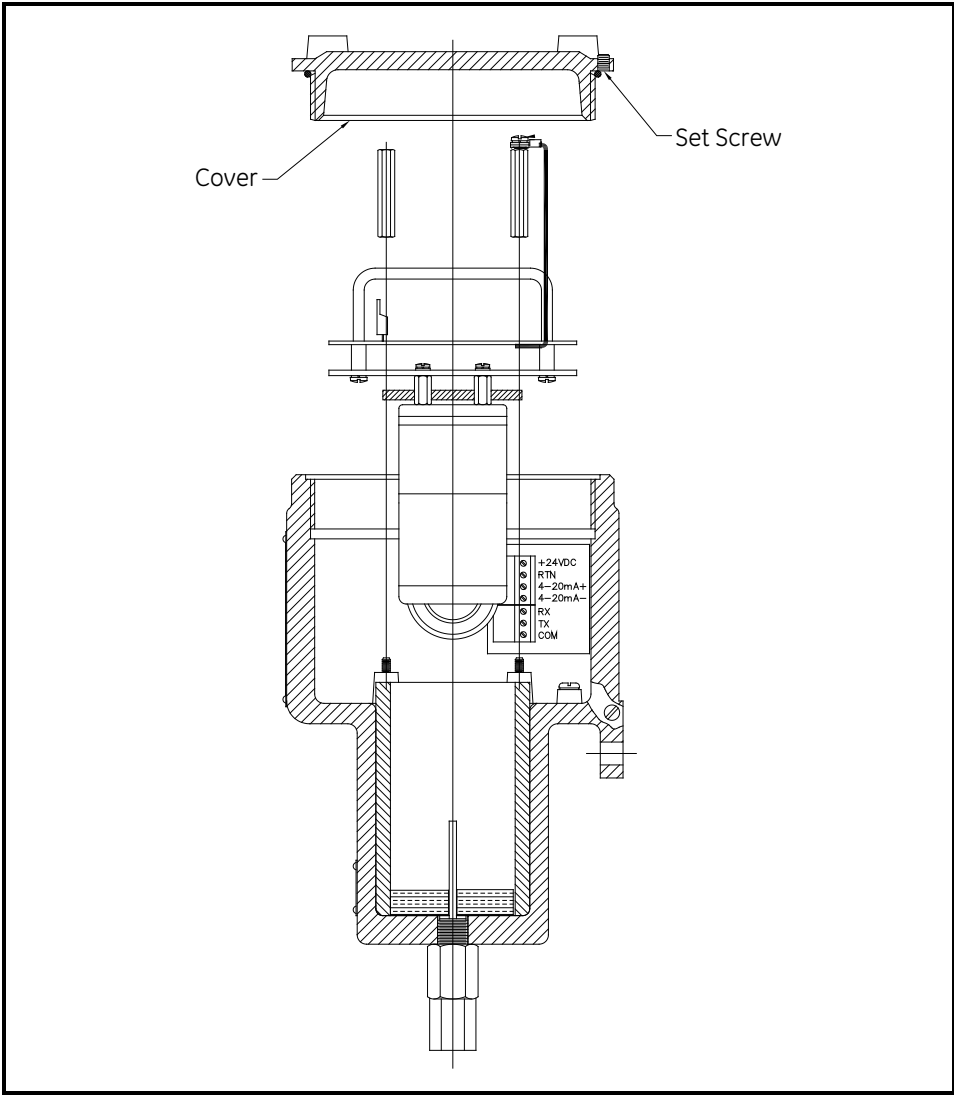

Figure 53: Transmitter Cover and Set Screw

4.4 Preparing the Transmitter for Calibration (cont.)

3. The XMTC printed circuit board (PCB) is located directly below the cover. Locate the switches **S1** (zero and span adjustment) and **S3** (calibration button) using *Figure 54* below as a guide.

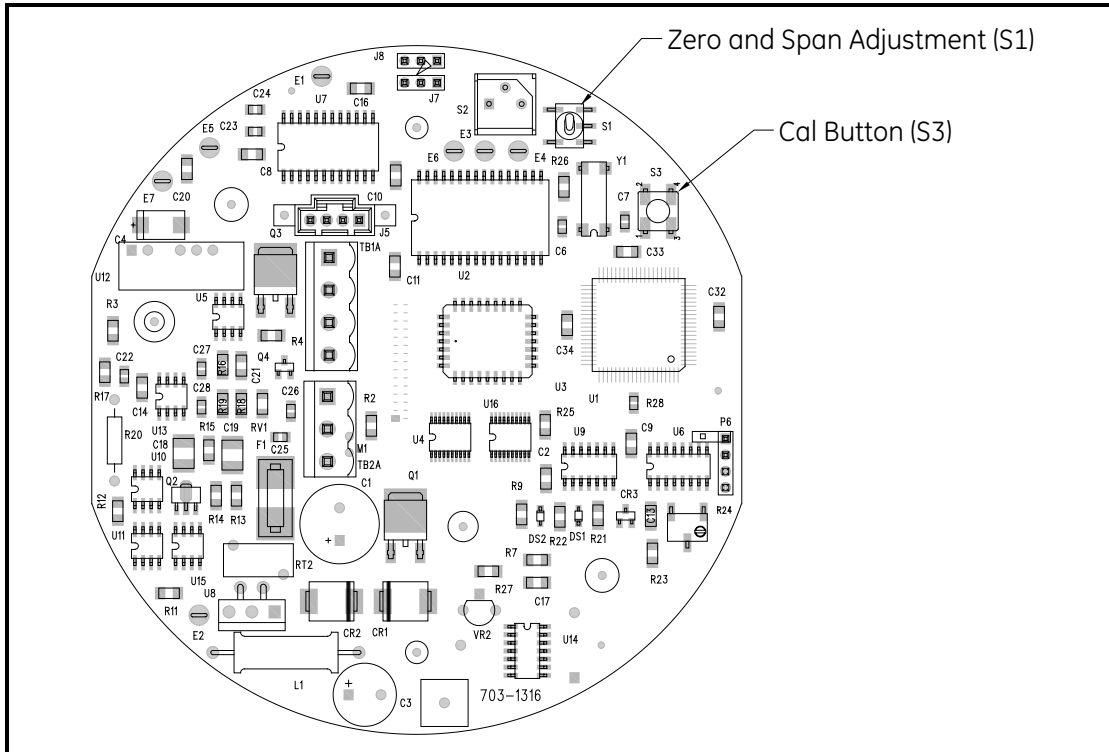

Figure 54: Calibration Switch Locations

4.5 2-Port (Sealed Reference Gas) Calibration

1. Connect the XMTC Sample Inlet to the zero gas via the Zero Gas Inlet on the sample system or other gas control system.
2. Establish a flow rate of 0.5 SCFH (250 cc/min) of zero gas at 0.0 psig to the XMTC.
3. Allow 2-5 minutes for the reading to settle. Move **S1** to the zero position (marked on the PCB). Press **S3** (the calibration button) for about 20 seconds.
4. Connect the XMTC Sample Inlet to the span gas via the Span Gas Inlet on the sample system or other gas control system.
5. Establish a flow rate of 0.5 SCFH (250 cc/min) of span gas at 0.0 psig to the XMTC.
6. Allow 2-5 minutes for the reading to settle. Move **S1** to the span position (marked on the PCB). Press **S3** (the calibration button) for about 20 seconds.

4.6 4-Port (Flowing Reference Gas) Calibration

1. Connect the XMTC Reference Inlet to the reference (span) gas via the Reference Gas Inlet on the sample system or other gas control system.
2. Establish a flow rate of 0.5 SCFH (250 cc/min) of reference (span) gas at 0.0 psig to the XMTC Reference Inlet.

Note: *You can use a calibration gas flow rate as low as 5 cc/min to conserve gas.*

3. Connect the XMTC Sample Inlet to the zero gas via the Zero Gas Inlet on the sample system or other gas control system.
4. Establish a flow rate of 0.5 SCFH (250 cc/min) of zero gas at 0.0 psig to the XMTC Sample Inlet.
5. Allow 2-5 minutes for the reading to settle. Move **S1** to the zero position (marked on the PCB). Press **S3** (the calibration button) for about 20 seconds.
6. Connect the XMTC Sample Inlet to the span gas via the Span Gas Inlet on the sample system or other gas control system.
7. Establish a flow rate of 0.5 SCFH (250 cc/min) of span gas at 0.0 psig to the XMTC Sample Inlet.
8. Allow 2-5 minutes for the reading to settle. Move **S1** to the span position (marked on the PCB). Press **S3** (the calibration button) for about 20 seconds.

[no content intended for this page]

Chapter 5. Specifications

5.1 Performance

Accuracy	$\pm 2\%$ of span
Linearity	$\pm 1\%$ of span
Repeatability	$\pm 0.5\%$ of span
Stability	<i>Zero:</i> $\pm 0.5\%$ of span per week <i>Span:</i> $\pm 0.5\%$ of span per week
Response Time	20 seconds for 90% of step change
Measurement Ranges (typical)	0-2% 0-5% 0-10% 0-25% 0-50% 0-100% 50-100% 80-100% 90-100% 95-100% 98-100%
Measurement Gases (typical)	H ₂ in N ₂ , air or CO ₂ He in N ₂ or Air CO ₂ in N ₂ or Air (minimum range 0-20% CO ₂) SO ₂ in Air (minimum range 0-10% SO ₂) Ar in N ₂ or air (minimum range 0-20% argon)
Ambient Temperature Effect	$\pm 0.05\%$ of span per °C
Required Sample Gas Flow Rate	0.1 to 4.0 SCFH (5 to 2000 cc/min), 0.5 SCFH (250 cc/min) nominal
Required Reference Gas Flow Rate	0.01 to 4.0 SCFH (5 to 2,000 cc/min), 0.5 SCFH (250 cc/min) nominal

5.2 Functional

Analog Output	4-20 mA isolated, 800 ohm max, field-programmable
Power	24 VDC \pm 2 VDC, 1.2 A maximum
Cable	10 ft (3 m), 4-wire; lengths up to 4000 ft. (1200 m) available
Operating Temperature	<i>Standard:</i> +55°C (+131°F) <i>Optional:</i> +70°C (+158 °F)
Ambient Temperature Range	<i>Standard cell operating temperature (55°):</i> -20° to +45°C (-4° to +104°F) <i>Optional cell operating temperature (70°):</i> +5° to +60°C (+41° to +140°F)

5.3 Physical

Sensor Wetted Materials	<i>Standard:</i> 316 SS, glass, and Viton™ o-rings <i>Optional:</i> Hastelloy C276, Titanium and Chemraz™ o-rings
Dimensions	<i>Weatherproof unit:</i> 9.54" (H) x 5.70" (D) (242 x 145 mm) <i>Explosion-proof unit:</i> 10.48" (H) x 5.70" (D) (266 x 145 mm)
Weight	9.5 lb (4.3 kg)
Connections	<i>Electrical conduit:</i> 3/4" NPTF <i>Sample inlet/outlet, optional reference inlet/outlet:</i> 1/4" NPTF
Environmental	<i>Weatherproof:</i> Class I Div. 1 Groups A, B, C & D Class II, III Div. 1 Groups E, F & G Tamb 65°C T5 Type 4X <i>Flameproof:</i> ITS12ATEX17703X IECEX ITS 12.0058X II 2 G Ex d IIC T6 Gb IP66 -20°C < Tamb < +65°C All conduit entries 3/4" NPT <i>CE:</i> EMC 2004/108/EC PED 97/23/EC Note: <i>For CE compliance, the power and I/O cables must be shielded. All cables must be terminated within the cable gland at the XMTC.</i> Note: <i>See the Certification Drawings in Appendix C, Installation and Wiring Diagrams, for additional details.</i>

5.4 Accessories

The following accessories are available for use with the XMTC:

- **PS5R-C24** - 24 VDC power supply
- **X4 (*)** - 4-wire cable (X specifies length), lengths up to 4000 ft (1200 m) are available
- **TMO2D** - display/control module
- **MIS-1** and **MMS-3** - graphical moisture, temperature, oxygen and thermal conductivity analyzers
- **XDP** - explosion-proof display package
- **704-668-12** - RS232 cable, 12 ft (4 m) length with DB-9 female connector
- **IDM** - manual and software with floppy disk (part number 910-185)
- **PanaView** - interface software manual and CD (part number 910-211)

[no content intended for this page]

Appendix A. Supplemental Information

A.1 Ordering Information



B - Measuring Cell Package*

1. Weatherproof enclosure, sealed reference (2-port), CPVC cell
2. Explosion-proof enclosure, sealed reference (2-port), CPVC cell
3. Weatherproof enclosure, flowing reference (4-port) CPVC cell
4. Explosion-proof enclosure, flowing reference (4-port) CPVC cell
5. Weatherproof enclosure, sealed reference (2-port) FEP-coated aluminum cell*
6. Explosion-proof enclosure, sealed reference (2-port) FEP-coated aluminum cell*
- W. Without enclosure, sealed reference (2-port), FEP-coated aluminum cell
- X. Without enclosure, sealed reference (2-port), CPVC cell
- Y. Without enclosure, flowing reference (4-port), CPVC cell

*Standard measuring cell package is FEP coated aluminum cell — see options 5 and 6 above.

C - CE Compliance

2. Standard
- C. CE Compliant

D - Certification Label for Explosion-Proof Options

1. T6 rating label, for ambient temperatures up to 55°C
2. T5 rating label, for ambient temperatures up to 65°C

E - Wetted Material

1. 316 Stainless Steel/Viton O rings
2. Hastelloy C276/Chemraz O rings

A.3 XMTC PCB Subassemblies

703-1276-02	XMTC transmitter analog PCB assembly
707-320	XMTC instrument program
703-1316-03	XMTC transmitter digital PCB assembly compatible with IDM communications software
910-185	Instrument Data Manager software and manual (supplied on floppy disk)
CREDIT-XMTC	Trade-in credit for uncontaminated XMTC. Partial credit to be determined after receipt and upon inspection at the factory.

A.4 Sample Calibration Sheet

A typical calibration sheet example is shown in *Figure 55* below.

XMTC Calibration Sheet				
XMTC S/N:	2630			
XMTC Part Number:	XMTC-62-11			
Calibration Part Number:	XMTC-CAL-311			
Calibration Gases:	H2/N2			
Calibration Ranges:	0 to 5%			
Work Order Number:	508230006418			
Calibration Date:	April 24, 2009			
Technician:	K. Brin			
Unit Calibrated Using	x10	Gain Scale		
XMTC Calibration Data				
Hydrogen in Nitrogen				
PT	%H2	x10 (mV)	Output (mA)	
1	0.00	-56.02	4.00	
2	5.00	574.00	20.00	
Output:	4 to 20 mA	0 to 5% H2 in N2		
Clamp Output:	No			
Field Calibration.				
Zero:	100% N2			
Span:	5% H2 in N2			

Figure 55: A Sample Calibration Sheet

A.5 Relative Thermal Conductivity of Common Gases

Table 4: Thermal Conductivity of Common Gases

Gas	Temperature = 0°C (32 °F)	Temperature = 100°C (212°F)
Air, N ₂ /O ₂	1.000	1.000
Hydrogen, H ₂	6.968	6.803
Helium, He	5.970	5.530
Nitrogen, N ₂	1.000	0.989
Oxygen, O ₂	1.018	1.028
Neon, Ne	1.900	1.840
Argon, Ar	0.677	0.665
Chlorine, Cl ₂	0.323	0.340
Carbon Monoxide, CO	0.962	0.958
Carbon Dioxide, CO ₂	0.603	0.704
Nitric Oxide, NO	0.980	0.978
Sulfur Dioxide, SO ₂	0.350	0.381
Hydrogen Sulfide, H ₂ S	0.538	0.562
Carbon Disulfide, CS ₂	0.285	0.300
Ammonia, NH ₃	0.897	1.040
Water Vapor, H ₂ O	0.755	0.771
Methane, CH ₄	1.250	1.450
Ethane, C ₂ H ₆	0.750	0.970
Propane, C ₃ H ₈	0.615	0.832
n-Butane, C ₄ H ₁₀	0.552	0.744
Isobutane, C ₄ H ₁₀	0.569	0.776
n-Pentane, C ₅ H ₁₂	0.535	0.702
Isopentane, C ₅ H ₁₂	0.515	0.702
n-Hexane, C ₆ H ₁₄	0.508	0.662
n-Heptane, C ₇ H ₁₆	0.399	0.582
Cyclohexane, C ₆ H ₁₂	0.375	0.576
Ethylene, C ₂ H ₄	0.720	0.980
Propylene, C ₃ H ₆	0.626	0.879
Acetylene, C ₂ H ₂	0.770	0.900
1,3 Butadiene, C ₄ H ₆	0.441	0.642
Nitrous Oxide, N ₂ O	0.633	0.762
Ethylene Oxide, C ₂ H ₄ O	0.469	0.620
Ethyl Alcohol, C ₂ H ₅ OH	0.590	0.685
Isopropyl Alcohol*, C ₃ H ₇ OH	0.492	0.644
Acetone, C ₃ H ₆ O	0.406	0.557
Methyl Chloride, CH ₃ Cl	0.377	0.530
Ethyl Chloride, C ₂ H ₅ Cl	0.391	0.540
Vinyl Chloride, C ₂ H ₃ Cl	0.443	0.551
Freon-11, CCl ₃ F	0.286	0.368
Freon-12, CCl ₂ F ₂	0.344	0.442
Freon-22, CHClF ₂	0.388	0.474
Freon-113, C ₂ Cl ₃ F ₃	0.277	0.369
Hydrogen Chloride, HCl	0.520	0.517
Hydrogen Fluoride, HF	0.654	0.959
*Consult GE		

[no content intended for this page]

Appendix B. Typical Applications

B.1 H₂ in N₂ in Heat Treat Furnace Atmospheres

The XMTC can be used to measure the concentration of hydrogen (H₂) in nitrogen (N₂) in a heat treat furnace atmosphere.

B.1.1 Problem

Mixtures of H₂ and N₂ are used as controlled atmospheres in the heat treating of metals. These mixtures are well-defined and need to be maintained in order to assure product quality and consistency. Dissociated ammonia is one such atmosphere. Here, ammonia is broken down into free N₂ and H₂ in a 25 to 75% mixture.

B.1.2 Equipment

A typical instrumentation package includes a 2-port (Sealed Reference Gas - air) XMTC transmitter with a 4-20 mA range of 0-25% H₂ mounted in a sample system similar to the one shown in *Figure 56* below. A display package is often specified.

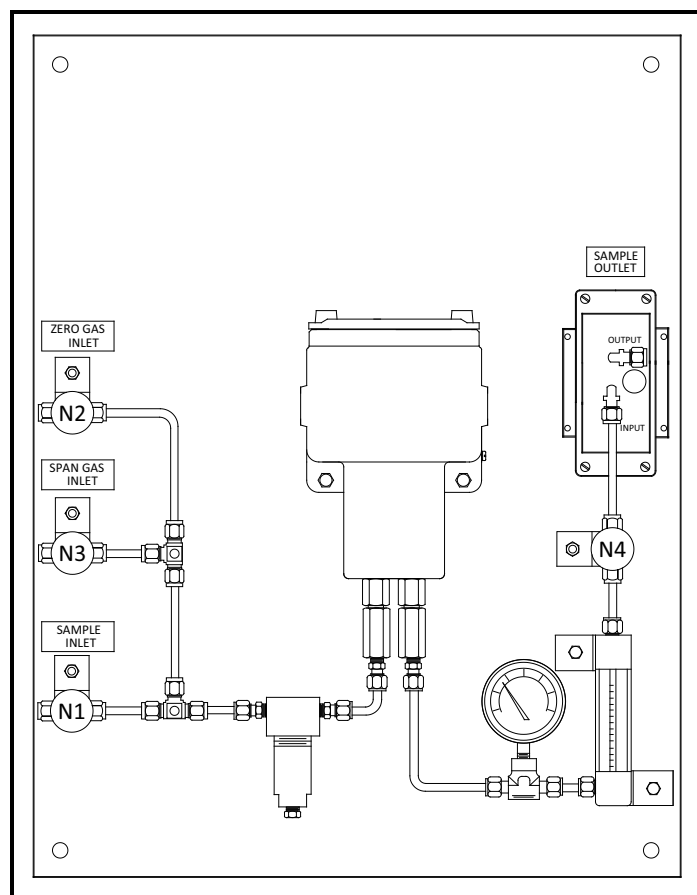

Figure 56: Sample System

B.1.2 Equipment (cont.)

The sample system consists of needle valves for selection and isolation of sample, zero, and span gases, a needle valve for flow control, a filter/coalescer, a 2-port XMTC transmitter, a pressure gauge, a flowmeter, and a sample pump. All components are mounted on a painted steel plate.

Note: A TMO2D or XDP display package is typically used. A GE moisture analyzer can be used when the H_2 measurement is to be made in conjunction with a moisture measurement.

B.1.3 Basic Operating Procedure

The H_2 content is continuously monitored at the inlet, hot zone, and/or effluent of the furnace. A sample gas flow rate of 0.5 SCFH (250 cc/min) is established. The sample system should be located in an area cooler than 50°C (122°F), and the tubing leading to the sample system should be at least 5 ft (1.5 m) long to insure proper cooling of the sample gas.

For this application the required calibration gases are:

- Zero gas - N_2 (99.95 % minimum purity)
- Span gas - 10.0 or 25.0% H_2 in N_2 , or H_2 (99.95 % minimum purity)

A typical XMTC Calibration Data Sheet is shown in Figure 57 below.

XMTC CALIBRATION SHEET		
THERMAL CONDUCTIVITY TRANSMITTER		
Serial Number	TC-102	
Part Number	XMTC-22-2	
Range, %	0 to 25% H_2	
Output	4 to 20 mA	
PC Board	703-1095	
Work Order:	PCI 90403	
Calibration Date:	September 18, 2000	
	Point	% H_2 * H_2 , mA
	1	0.00 4.00
	2	25.00 20.00
*Calibration is with Hydrogen (H_2) in Nitrogen (N_2)		

Figure 57: A Typical XMTC Calibration Data Sheet

B.1.4 Permanent Installation

Continuous monitoring of the furnace atmosphere H_2 content using the XMTC assures a high degree of quality control in the manufacturing process.

B.1.5 Specifications

Typical Ranges:

0 to 10% H_2 in N_2

0 to 25% H_2 in N_2

0 to 100% H_2 in N_2

Operating Conditions:

Pressure: Ambient

Temperature: +540 to +1370 °C (+1000 to +2500°F)

B.1.6 Detailed Operating Procedure

The following procedure details the start-up, operation, and calibration of the 2-port (Sealed Reference Gas) XMTC sample system for heat treat furnace applications shown in *Figure 56 on page 59*.

Needle valves N1 through N4 on the sample system drawing have the following functions:

- N1 – selects/isolates the process sample gas
- N2 – selects/isolates the calibration zero gas
- N3 – selects/isolates the calibration span gas
- N4 – controls the flow of the selected gas

B.1.6a Start-up

1. Mount the sample system in an enclosed area heated to a temperature above 0°C.
2. Make sure that all needle valves are fully closed.
3. Run 1/4" tubing from the process to N1 (*Sample Inlet*).

Note: *If the process is at a high pressure, a pressure regulator should be placed before this valve.*



CAUTION! The XMTC is calibrated and intended for use at atmospheric pressure. Higher pressures will lead to inaccurate readings, may result in damage to the instrument, and/or may pose a safety problem.

4. Run 1/4" tubing from the pressure regulator on the cylinder containing the zero calibration gas to N2 (*Zero Gas Inlet*).
5. Run 1/4" tubing from the pressure regulator on the cylinder containing the span calibration gas to N3 (*Span Gas Inlet*).

Note: *No pressure restrictions should be placed on the pump outlet. Any tubing on the outlet should be at least 1/4" in diameter, and preferably 1/2".*

6. Leak test all sample system fittings, as well as those leading to the sample system.
7. Bring 24 VDC to the XMTC. Refer to Chapter 2, *Installation*, and allow 1 hour before proceeding.
8. Bring 120 VAC to the sample pump.
9. Open N4 one turn.
10. Fully open N1.
11. Adjust N4 until the flowmeter reads mid-scale. The pressure gauge should read 0 psig.

After the system has come to equilibrium, the sample system should be checked periodically to ensure that there is gas flow through the flowmeter.

B.1.6b Calibration

Refer to Chapter 4, *Calibration*, for the complete XMTC calibration procedure. The procedures below are only a supplement to that procedure. These procedures show the valve configurations necessary to deliver the calibration gases to the XMTC.

Zero Gas Calibration:

1. Fully close N1.
2. Fully open N2.
3. Adjust N4 until the flowmeter reads mid-scale. The pressure gauge should read 0 psig.

Allow enough time for the tubing to be cleared of the sample gas before making any adjustments to the transmitter.

Span Gas Calibration:

1. Fully close N2 (or N1).
2. Fully open N3.
3. Adjust N4 until the flowmeter reads mid-scale. The pressure gauge should read 0 psig.

Allow enough time for the tubing to be cleared of the zero (or sample) gas before making any adjustments to the transmitter.

Returning to Standard Operation:

1. Fully close N3 (or N2).
2. Fully open N1.
3. Adjust N4 until the flow meter reads mid-scale. The pressure gauge should read 0 psig.

After the system has come to equilibrium, the sample system should be checked periodically to insure that there is flow through the flow meter.

B.2 H₂ Purity in H₂-Cooled Electricity Generator

The XMTC can be used to measure the purity of hydrogen (H₂) in hydrogen-cooled electricity generators used in the power industry.

B.2.1 Problem

H₂ is used as a cooling medium in electricity generators because of its high thermal conductivity. If air leaks into the H₂, the mixture can become explosive.

B.2.2 Equipment

A typical instrumentation package includes a 4-port (Flowing Reference Gas - hydrogen), explosion-proof XMTC transmitter with a 4-20 mA range of 80 to 100% H₂ mounted in a sample system similar to the one shown in *Figure 58* below. An XDP display package is often specified.

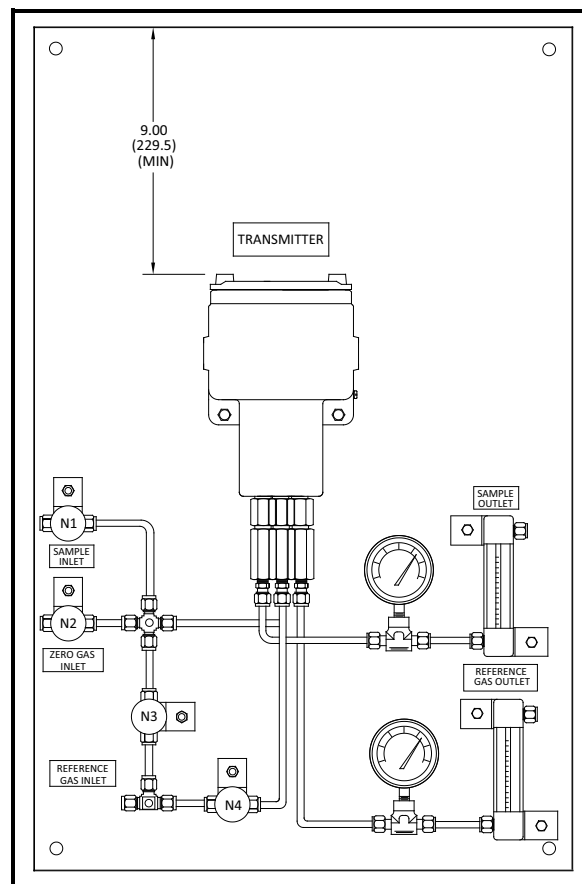

Figure 58: Sample System (732-028)

B.2.2 Equipment (cont.)

The sample system consists of inlet needle valves for sample, zero, span, and reference gases; a 4-port explosion-proof XMTC; two pressure gauges; and two flowmeters. All components are mounted on a painted steel plate. A pump may be needed to draw a sample through the sample system.

Note: A TMO2D or XDP display package is typically used. A GE moisture analyzer display package can be used when the H_2 measurement is to be made in conjunction with a moisture measurement.

B.2.3 Basic Operating Procedure

The H_2 purity is continuously monitored at the generator. A sample gas flow of 0.5 SCFH (250 cc/min) is established. A hydrogen reference gas flow of 0.4 SCFH (200 cc/min) is sufficient for proper operation. The sample system should be located in an area cooler than 50°C (122°F), and the tubing leading to the sample system should be at least 5 ft (1.5 m) long to insure proper cooling of the sample gas.

For this application the required calibration gases are as follows:

- Zero gas - 80.0% H_2 in N_2
- Span gas - H_2 (minimum 99.95 % purity)
- Reference gas - same as span gas

A typical XMTC Calibration Data Sheet is shown in Figure 59 below.

XMTC CALIBRATION SHEET			
THERMAL CONDUCTIVITY TRANSMITTER			
XMTC Transmitter			
Serial Number	TC-135		
Part Number	XMTC-42-1		
Range, %	80 to 100% H_2 in N_2		
Output	4 to 20 mA		
PC Board	703-1095		
Work Order:	PCI 94445		
Calibration Date:	September 1, 2000		
	Point	% H_2 *	H_2 , mA
	1	80.00	4.00
	2	90.00	11.62
	3	100.00	20.00
*Calibration is with Hydrogen (H_2) in Nitrogen (N_2)			

Figure 59: Typical XMTC Calibration Data Sheet

B.2.4 How Previously Handled

The system (generator) was leak checked periodically. If a leak occurred between checks, an explosion could occur. Moisture analyzers were also used for continuous analysis, since the presence of moisture in the H₂ is indirect evidence of an air leak.

B.2.5 Permanent Installation

Continuous monitoring of the generator H₂ purity using the XMTC provides increased safety. A low H₂ reading alerts plant personnel to a potential safety problem and allows them to locate the leak and correct the problem.

B.2.6 Specifications

Range:

80 to 100% H₂ in N₂

Operating Conditions:

Pressure: 0.5 to 75 psig

Temperature: +30° to +50 °C (+86 to +122°F)

B.2.7 Detailed Operating Procedure

The following procedure details the start-up, operation, and calibration of the 4-port (Flowing Reference Gas) XMTC sample system for the hydrogen purity applications shown in *Figure 58 on page 64*.

Needle valves N1 through N4 on the sample system drawing have the following functions:

- N1 – controls the flow of the process sample gas
- N2 – controls the flow of the zero calibration gas
- N3 – controls the flow of the span calibration gas
- N4 – controls the flow of the reference gas

B.2.7a Start-up

1. Mount the sample system in an enclosed area heated to a temperature above 0°C.
2. Make sure that all needle valves are fully closed.
3. Run 1/4" tubing from the process to N1 (*Sample Inlet*).

Note: *If the process is at a high pressure, a pressure regulator should be placed before this valve.*



CAUTION! The XMTC is calibrated and intended for use at atmospheric pressure. Higher pressures will lead to inaccurate readings, may result in damage to the instrument, and/or may pose a safety problem.

4. Run 1/4" tubing from the pressure regulator on the cylinder containing the zero calibration gas to N2 (*Zero Gas Inlet*).
5. Run 1/4" tubing from the pressure regulator on the cylinder containing the span calibration gas/reference gas to N4 (*Reference Gas Inlet*).

Note: *No pressure restrictions should be placed on the flowmeter outlets. Any tubing on the outlets should be at least 1/4" in diameter, and preferably 1/2".*

6. Leak test all sample system fittings, as well as those leading to the sample system.
7. Bring 24 VDC to the XMTC. Refer to Chapter 2, *Installation*, and allow 1 hour before proceeding.
8. Slowly open N1 until the sample outlet flowmeter reads mid-scale. The pressure gauge at the sample outlet should read 0 psig.
9. Slowly open N4 until the reference gas outlet flowmeter reads mid-scale. The pressure gauge at the reference gas outlet should read 0 psig.

After the system has come to equilibrium, the sample system should be checked periodically to insure that there is gas flow through both flowmeters.

B.2.7b Calibration

Refer to Chapter 4, *Calibration*, for the complete XMTC calibration procedure. The procedures below are only a supplement to that procedure. These procedures show the valve configurations necessary to bring the calibration gases to the XMTC.

Zero Gas Calibration:

1. Fully close N1 and/or N3.
2. Slowly open N2 until the sample outlet flowmeter reads mid-scale. The pressure gauge at the sample outlet should read 0 psig.

Note: *If N3 was closed in this step and if the flow in the reference gas outlet flowmeter increased when N3 was closed, adjust N4 to bring the flow to mid-scale.*

Allow enough time for the tubing to be cleared of the sample gas or calibration span gas before making any adjustments to the transmitter.

Span Gas Calibration:

1. Fully close N1 and/or N2.
2. Slowly open N3 until the sample outlet flowmeter reads mid-scale. The pressure gauge at the sample outlet should read 0 psig.

Note: *If the flow in the reference gas outlet flowmeter decreased when N3 was opened, adjust N4 to bring the flow to mid-scale.*

Returning to Standard Operation:

1. Fully close N2 and/or N3.

Note: *If N3 was closed in this step and if the flow in the reference gas outlet flowmeter increased when N3 was closed, adjust N4 to bring the reference gas flow to mid-scale.*

2. Slowly open N1 until the sample outlet flowmeter reads mid-scale. The pressure gauge at the sample outlet should read 0 psig.

After the system has come to equilibrium, the sample system should be checked periodically to insure that there is flow through both flow meters.

Appendix C. Installation and Wiring Diagrams

This appendix includes the following XMTC drawings in 11" x 17" fold-out format:

- Figure 60, "Certification Drawing (ref. 752-168, Rev. E, SH1)," on page 71
- Figure 61, "Certification Drawing (ref. 752-168, Rev. E, SH2)," on page 72
- Figure 62, "Certification Drawing (ref. 752-168, Rev. E, SH4)," on page 73
- Figure 63, "Analog PCB Schematic (ref. 700-1276, Rev. F, SH1)," on page 74
- Figure 64, "Analog PCB Schematic (ref. 700-1276, Rev. F, SH2)," on page 75
- Figure 65, "Digital PCB Schematic (ref. 700-1316, Rev. H, SH1)," on page 76
- Figure 66, "Digital PCB Schematic (ref. 700-1316, Rev. H, SH2)," on page 77
- Figure 67, "EMI Filter PCB Schematic (ref. 700-1550, Rev. A)," on page 78
- Figure 68, "Analog PCB Assembly (ref. 703-1276, Rev. H)," on page 79
- Figure 69, "Digital PCB Assembly (ref. 703-1316, Rev. K, SH1)," on page 80
- Figure 70, "Digital PCB Assembly (ref. 703-1316, Rev. K, SH2)," on page 81
- Figure 71, "EMI Filter PCB Assembly (ref. 703-1550, Rev. A, SH1 & SH2)," on page 82
- Figure 72, "XMTC Interconnection Diagrams," on page 83

[no content intended for this page]

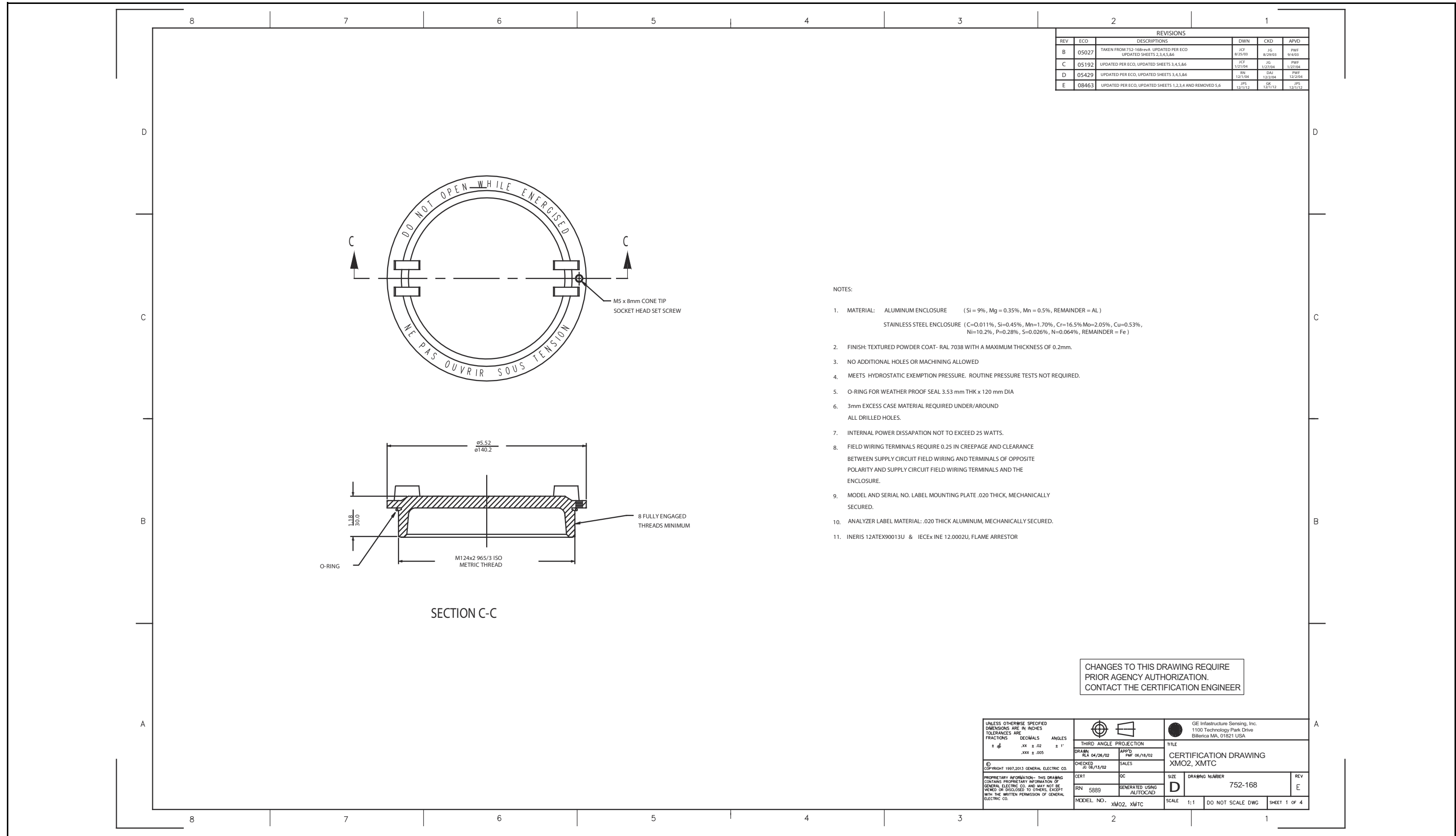

Figure 60: Certification Drawing (ref. 752-168, Rev. E. SH1)

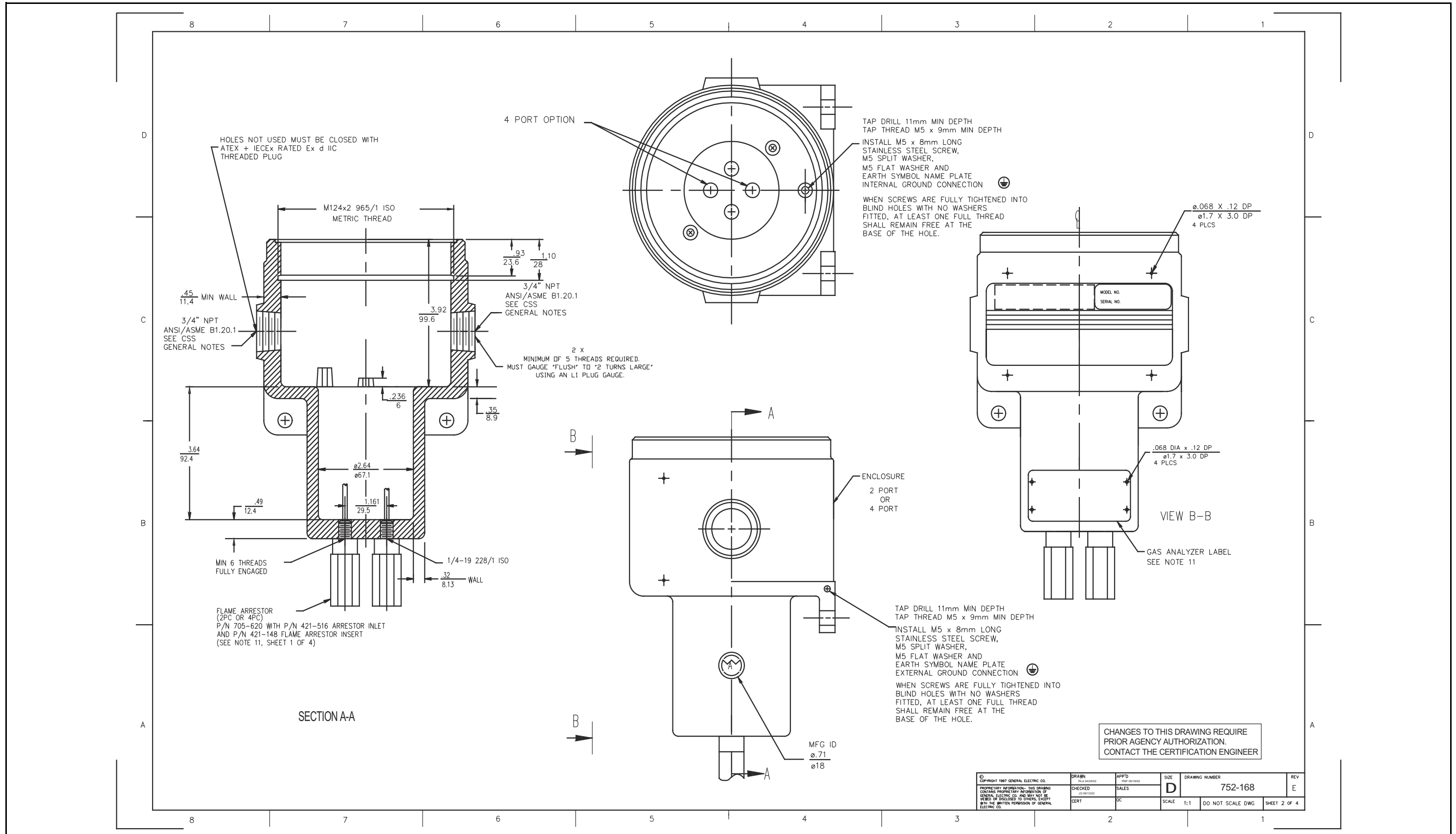

Figure 61: Certification Drawing (ref, 752-168, Rev. E, SH2)

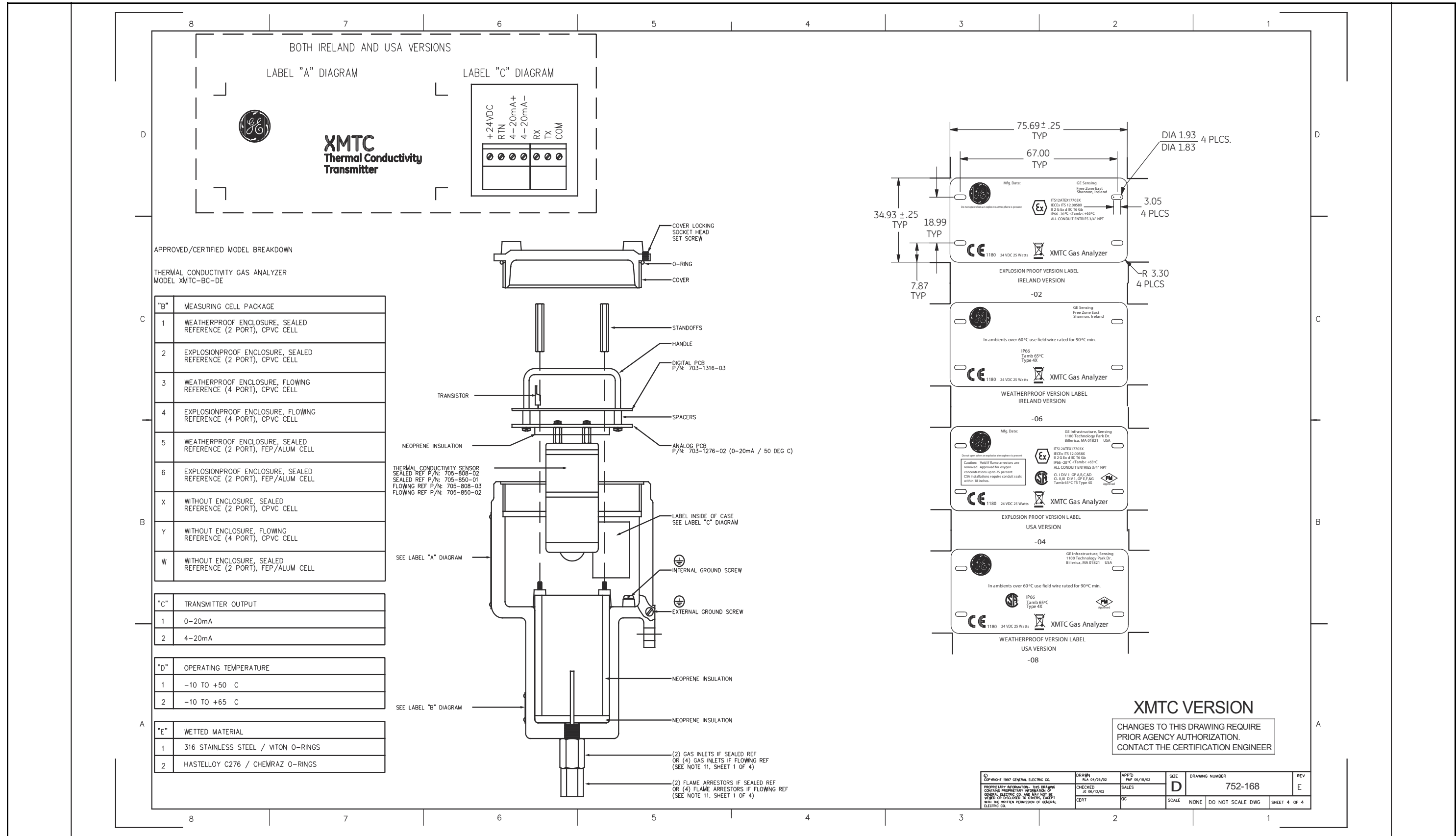

Figure 62: Certification Drawing (ref. 752-168, Rev. E, SH4)

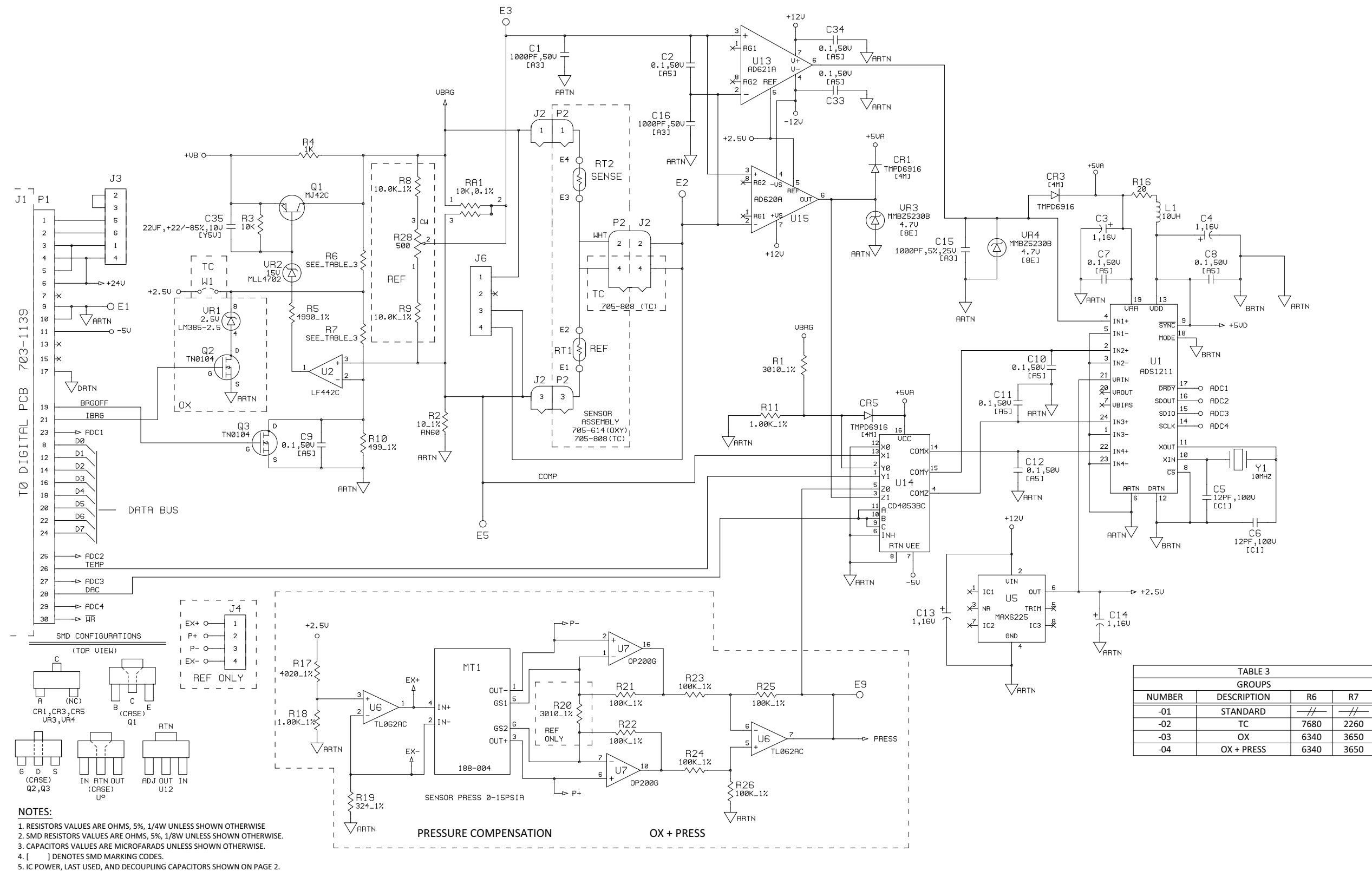

Figure 63: Analog PCB Schematic (ref. 700-1276, Rev. F, SH1)

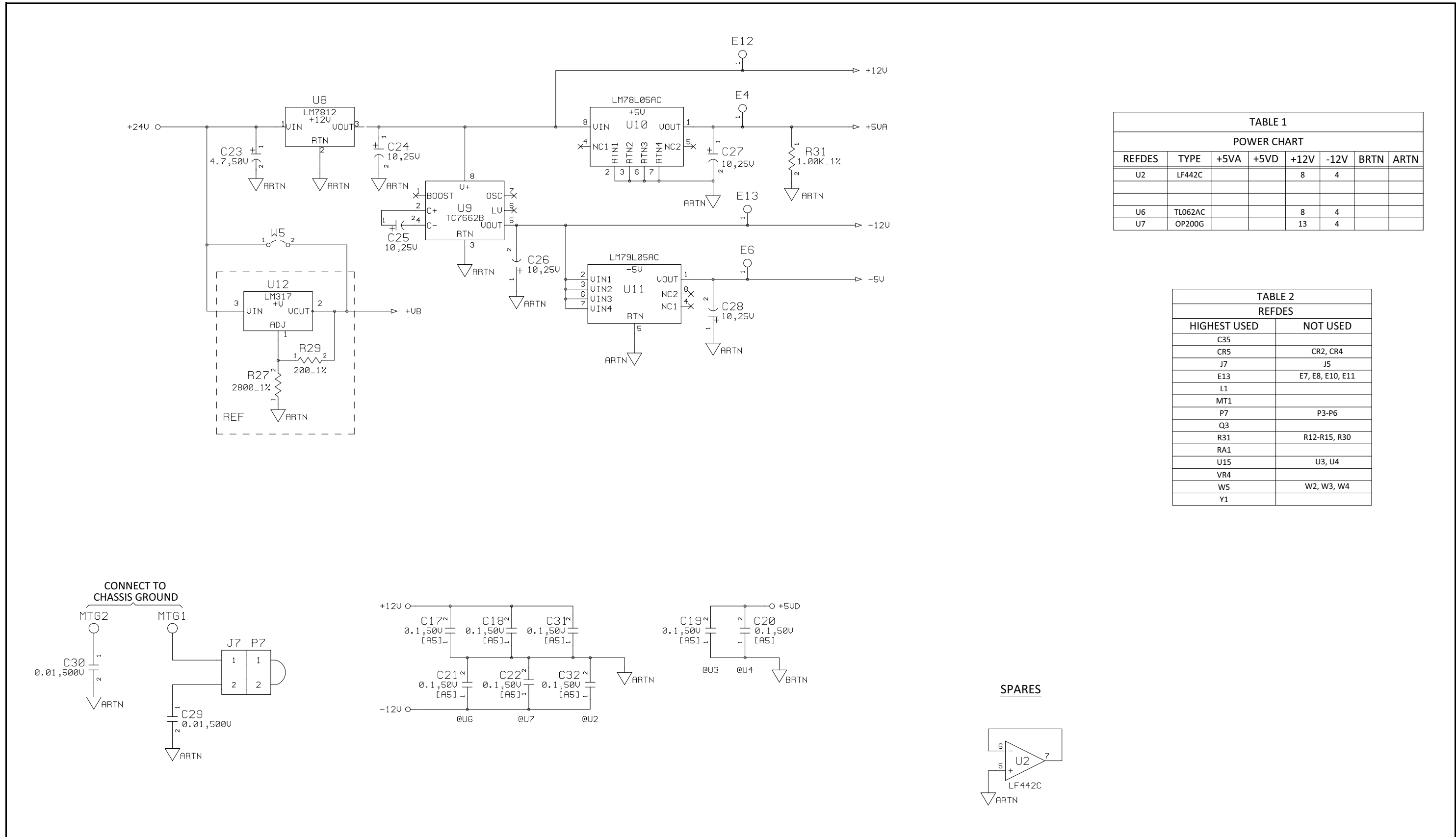

TABLE 1
POWER CHART

REFDES	TYPE	+5VA	+5VD	+12V	-12V	BRTN	ARTN
U2	LF442C			8	4		
U6	TL062AC			8	4		
U7	OP200G			13	4		

TABLE 2
REFDES

HIGHEST USED	NOT USED
C35	
CR5	CR2, CR4
J7	J5
E13	E7, E8, E10, E11
L1	
MT1	
P7	P3-P6
Q3	
R31	R12-R15, R30
RA1	
U15	U3, U4
VR4	
W5	W2, W3, W4
Y1	

Figure 64: Analog PCB Schematic (ref. 700-1276, Rev. F, SH2)

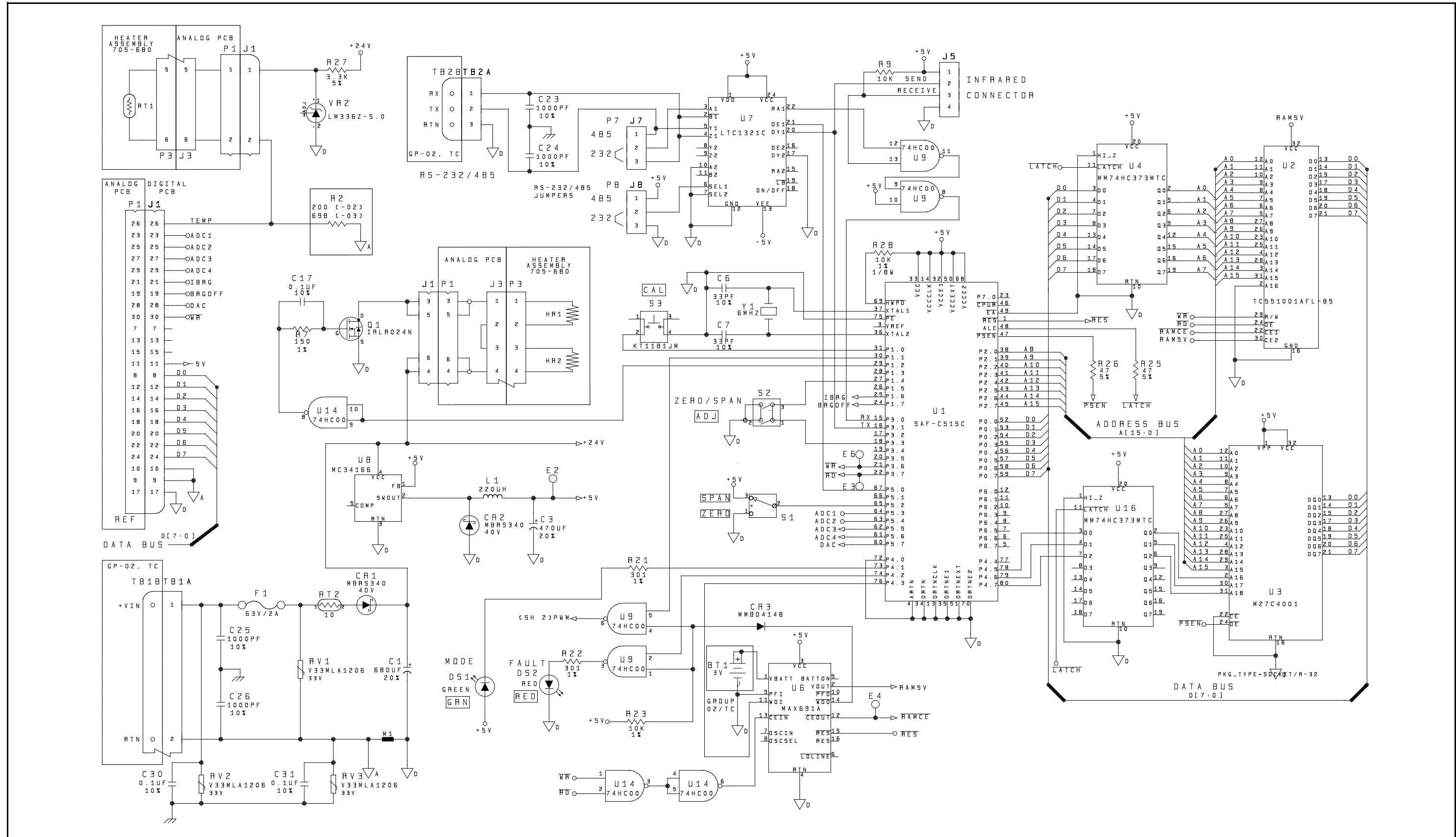

Figure 65: Digital PCB Schematic (ref. 700-1316, Rev. H, SH1)

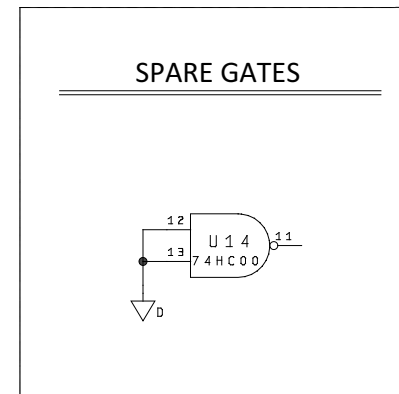
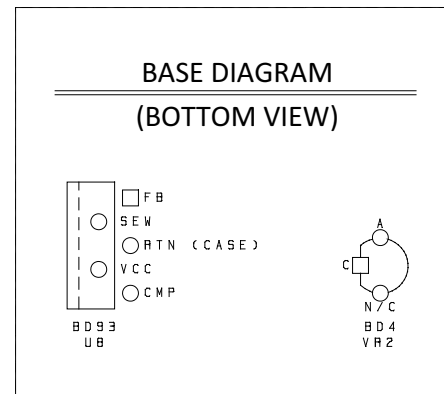
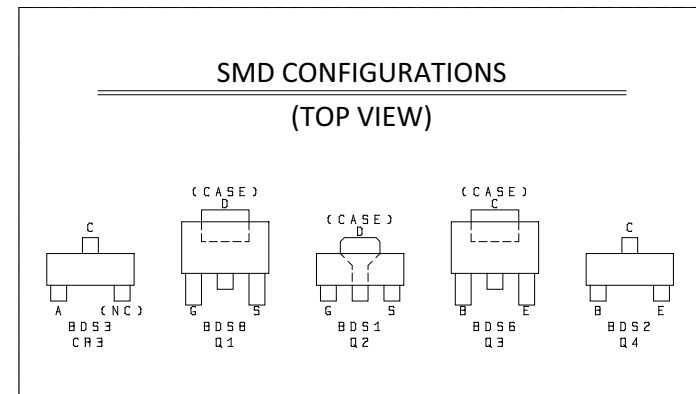

TABLE 1
POWER CHART

REF DES	TYPE	+5V	-5V	D	MISC
U9 U14	74HC00	14		7	
U13	AD822A				8 = VE 4 = E

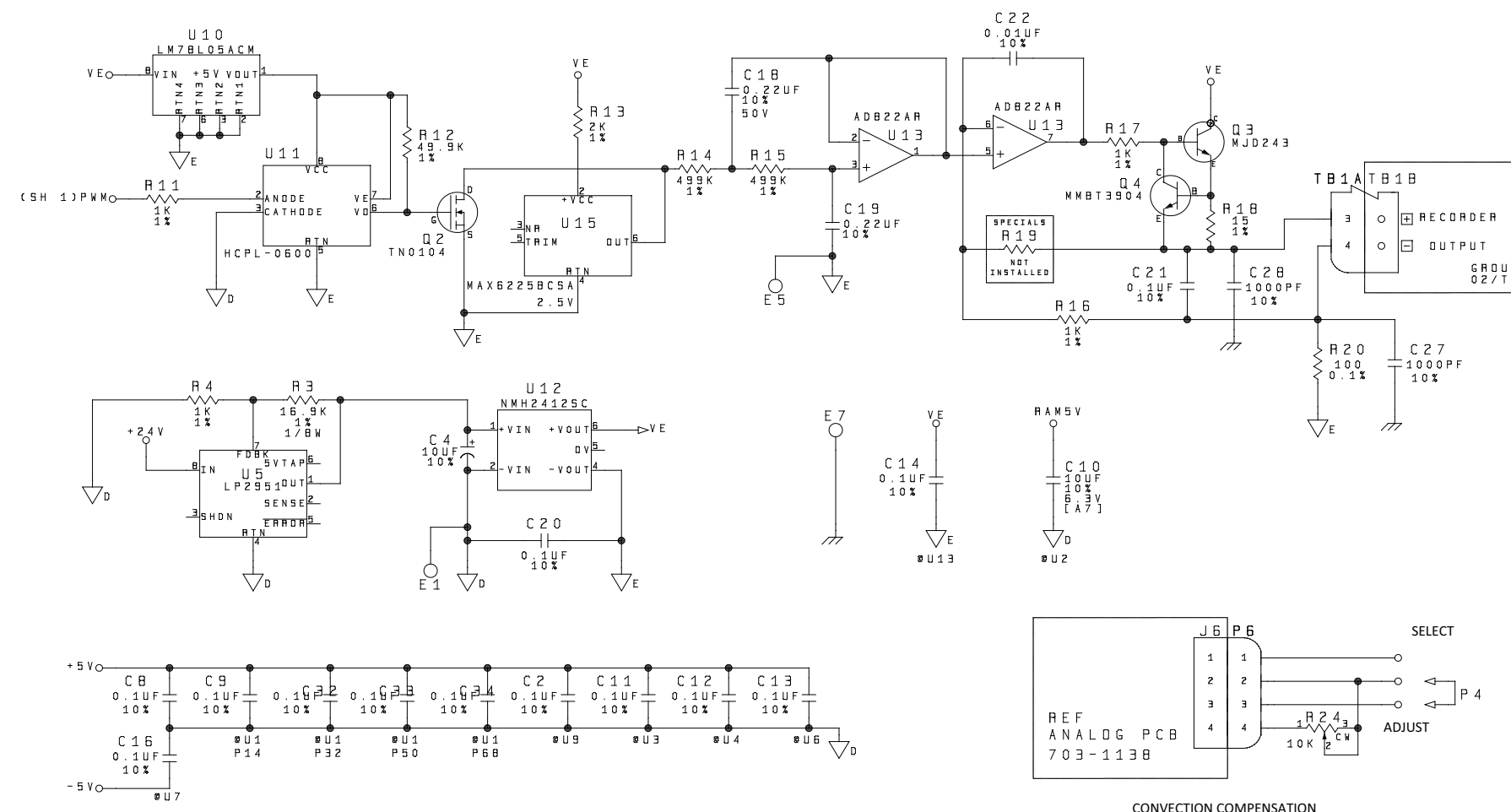

TABLE 2
GROUP CHART

HIGHEST USED	NOT USED
BT1	
C34	C5 C15 C29
CR3	
DS2	
E7	
F1	
JB	J2 J3 J4 J6
L1	
M1	
P8	P1 P2 P3 P5
Q4	
R28	R1 R5 R6 R8 R10
RT2	RT1
RV3	
S3	
TB2	
U15	
VR2	VR1
Y1	

TABLE 3
GROUP CHART

NUMBER	DESCRIPTION
01	STANDARD
02	O2
03	TC

- NOTES:
1. RESISTOR VALUES ARE EXPRESSED IN OHMS, 1%, 1/8W, UNLESS OTHERWISE SPECIFIED.
 2. CAPACITOR VALUES ARE EXPRESSED IN MICROFARADS, UNLESS OTHERWISE SPECIFIED.
 3. [] INDICATES MARKING.
 4. [] INDICATES SMD MARKING CODES.
 5. I.C. POWER, LAST USED, AND DECOUPLING CAPACITORS SHOWN ON PAGE 2.

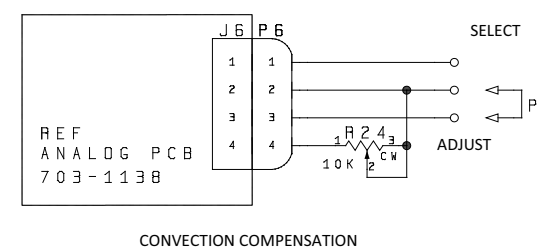

Figure 66: Digital PCB Schematic (ref. 700-1316, Rev. H, SH2)

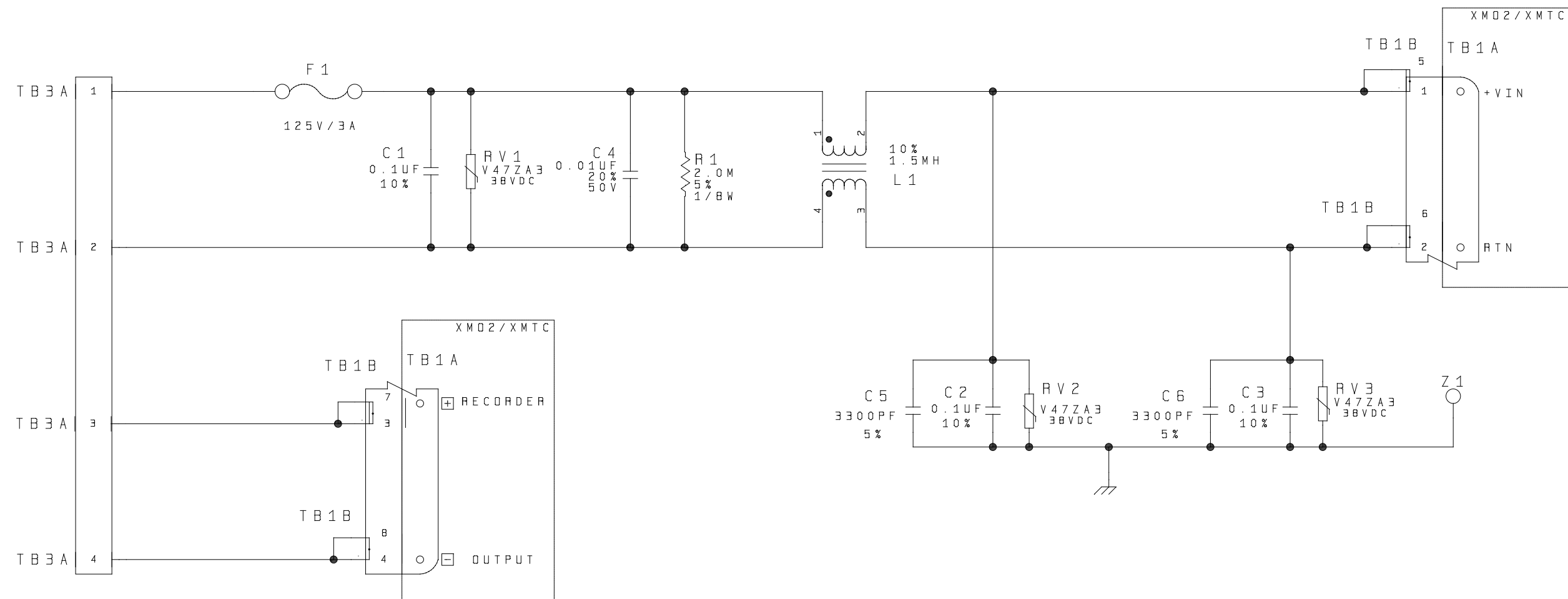

TABLE 1	
REF DES CHART	
HIGHEST USED	NOT USED
C6	
F1	
L1	
R1	
RV3	
TB1B	
TB3A	TB1A TB2A

Figure 67: EMI Filter PCB Schematic (ref. 700-1550, Rev. A)

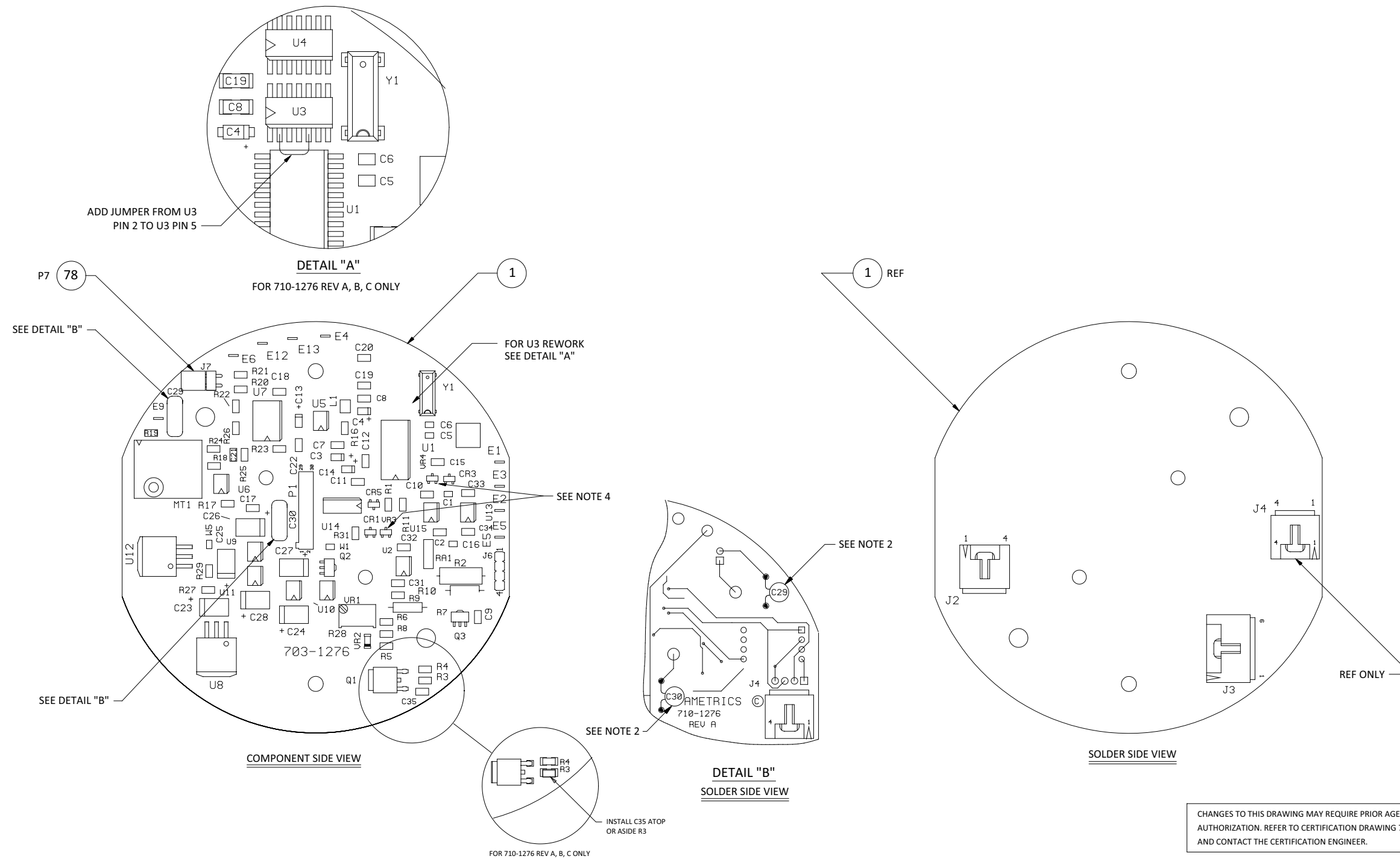
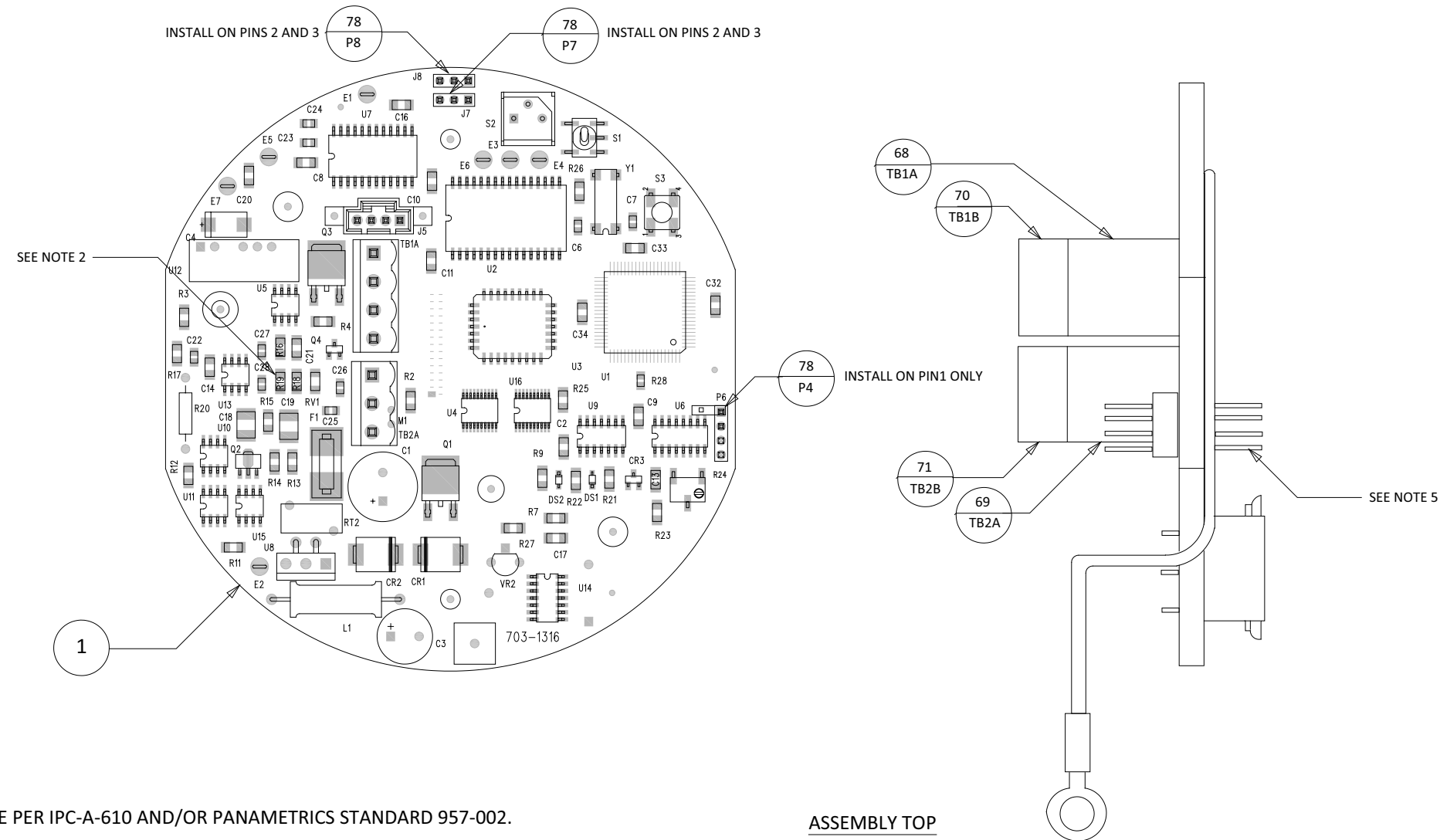

Figure 68: Analog PCB Assembly (ref. 703-1276, Rev. H)



NOTES:

1. ASSEMBLE PER IPC-A-610 AND/OR PANAMETRICS STANDARD 957-002.
2. R19 NOT INSTALLED (SPECIALS ONLY).
3. ALL UNINSTALLED COMPONENT HOLES TO BE SOLDER FREE.
4. DISCARD LOCKWASHER AND NUT ON S2 (DO NOT INSTALL).
5. INSTALL P6 WITH LONGER LEADS INTO PCB AS SHOWN FOR PROPER STACKUP WITH MATED ASSEMBLY. SOLDER MUST BE FLUSH TO BOARD. DO NOT CUT, TRIM OR TIN EXCESS LEADS.
6. INSTALL CHASSIS GROUND WIRE ON THE BOTTOM SIDE OF THE PCB. APPLY LOCTITE 416 INSTANT ADHESIVE AND LOCTITE 7452 ACCELERATOR OR EQUIVALENT TO TACK WIRE TO PCB.

GROUPS	
NO.	DESCRIPTION
01	STANDARD
02	02
03	TC

Figure 69: Digital PCB Assembly (ref. 703-1316, Rev. K, SH1)

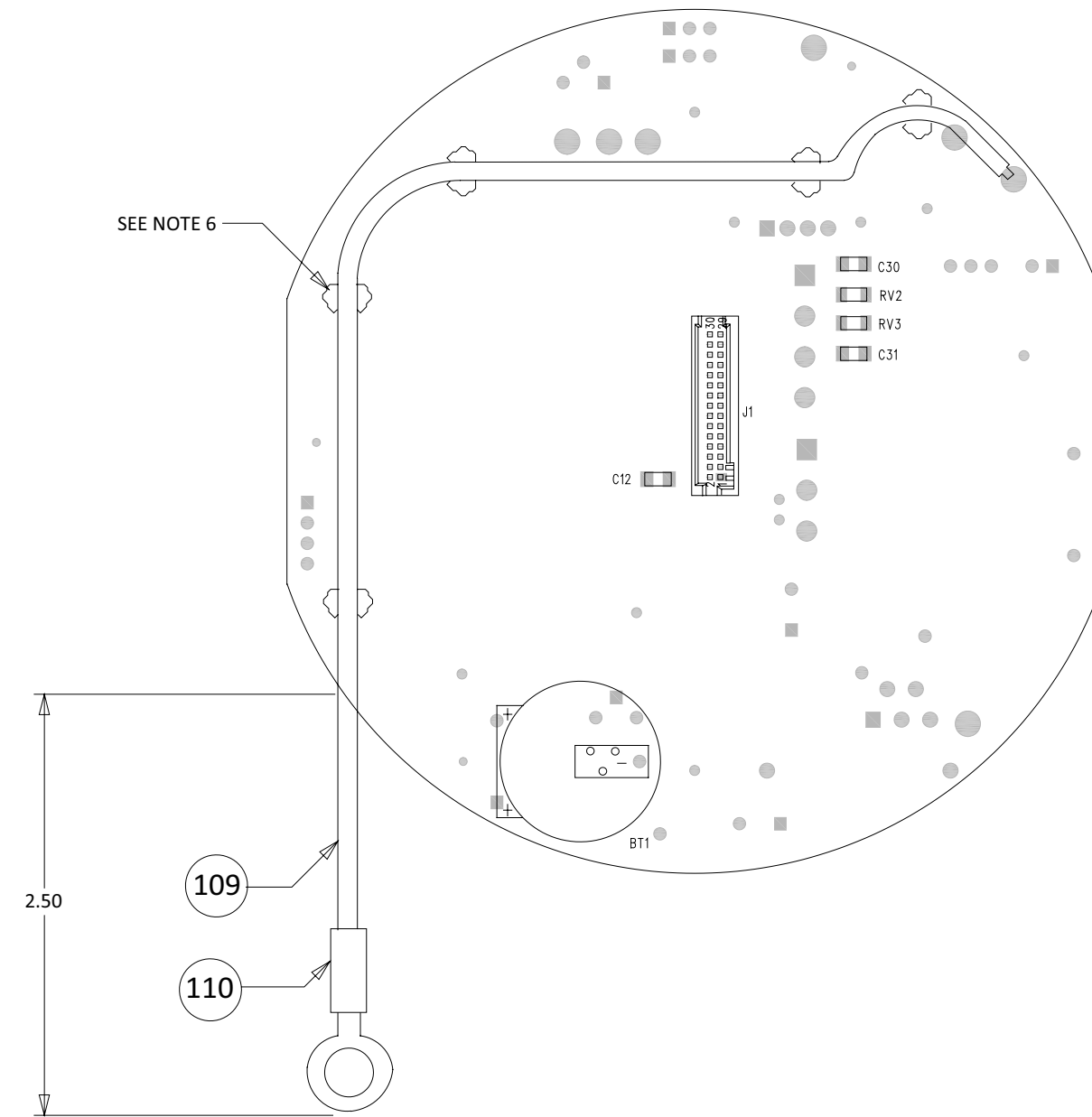

BOTTOM SIDE ASSEMBLY

Figure 70: Digital PCB Assembly (ref. 703-1316, Rev. K, SH2)

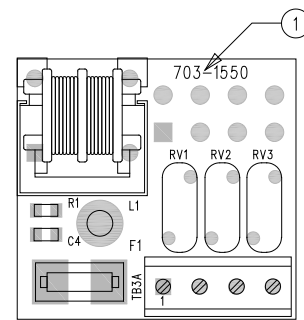

ASSEMBLY TOP

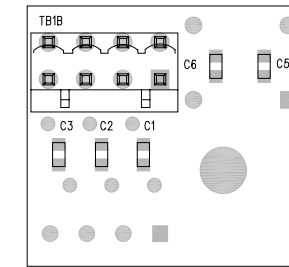

BOTTOM SIDE ASSEMBLY

NOTES:

1. ASSEMBLE PER IPC-A-610 AND/OR PANAMETRICS STANDARD 957-002.

Figure 71: EMI Filter PCB Assembly (ref. 703-1550, Rev. A, SH1 & SH2)

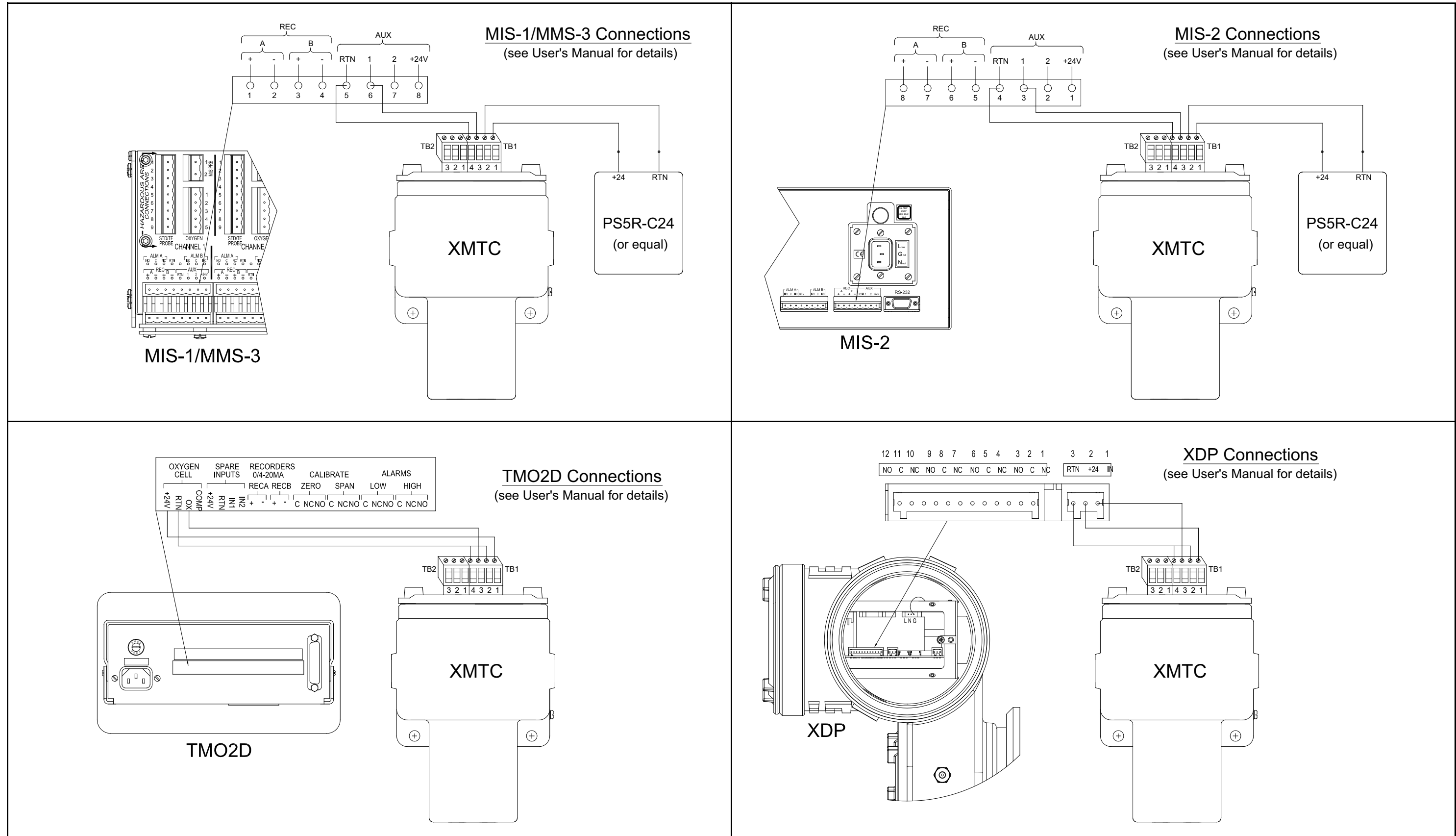

Figure 72: XMTc Interconnection Diagrams

[no content intended for this page]

Appendix D. The Enhanced Advanced Option

D.1 Entering the Enhanced Advanced Option

For internal technical support, the XMTC transmitter software includes in its *Edit Functions* submenu (*Advanced Option* command) several commands only accessible with factory authorization. Since improper programming could result in serious performance inaccuracies, these commands should only be accessed under direct factory supervision using the GE IDM™ software.

IMPORTANT: *You must contact GE before changing the parameters in this menu.*

To access the enhanced *Advanced Option*:

1. From the *Edit Functions* menu (see *Figure 10 on page 20*), click on *Advanced*.
2. When a window similar to *Figure 73* below opens, enter your factory-level password. Contact GE for the appropriate password.



Figure 73: Password Window

After you have entered the password, an *Advanced* window similar to *Figure 74* below opens.

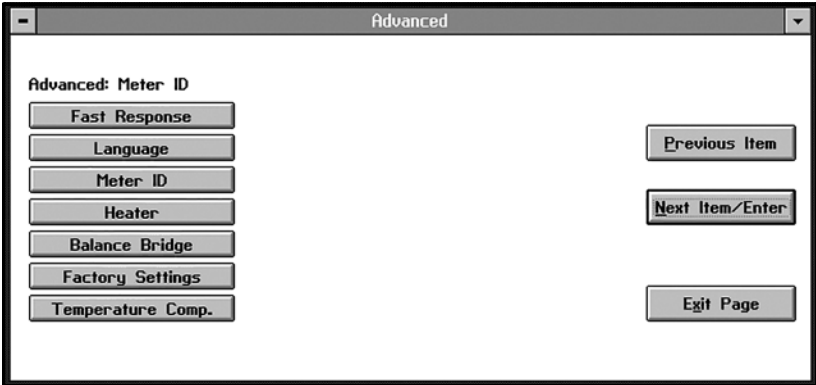

Figure 74: Advanced Window

D.1 Entering the Enhanced Advanced Option (cont.)

Along with *Fast Response*, *Language*, and *Meter ID* discussed in Chapter 3, the enhanced *Advanced Menu* offers four additional commands:

- **Heater** - sets a specified operating temperature for the XMTC cell.
- **Balance Bridge** - compensates the XMTC cell for nonlinearity in the bridge (for factory use only).
- **Factory Commands** - allows users to upload or download modified settings or to reset the values to the factory defaults.
- **Temperature Comp.** - allows entry of temperature calibration values (for factory use only).

Click on the desired option to open it, or click on *Next Item/Enter* to open the menu listed on the status line above the options. (Click *Previous Item* or *Exit Page* to close the window without entering any commands.)

D.2 Heater

The parameters in the *Heater* command affect the operation of the *Heater* controls. The window for the *Heater* command is similar to *Figure 75* below.

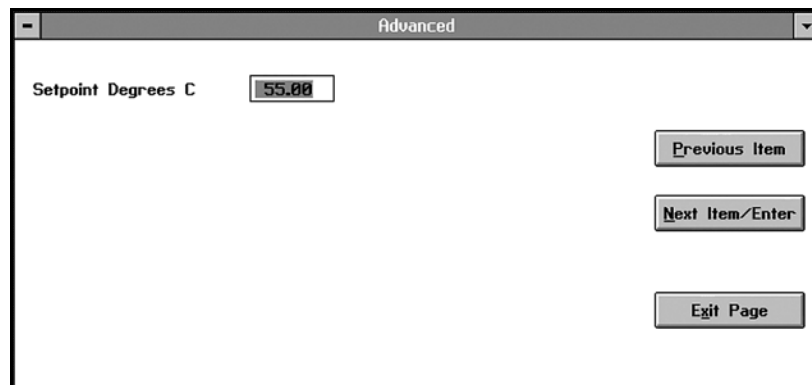

Figure 75: Temperature Comp. Window

The first command, *Setpoint Degrees C*, asks you to enter the *Heater Setpoint* (the temperature at which the cell is maintained). Enter the desired temperature (in degrees C) and press *Next Item/Enter* to confirm the entry. (For any command, click *Previous Item* to return to the previous parameter, or *Exit Page* to close the window without changing any values.)

D.2 Heater (cont.)

The next command, as shown in *Figure 76* below, asks you to enter the *Proportional Band* (in degrees C). This parameter should be set at 5° unless otherwise specified by GE.

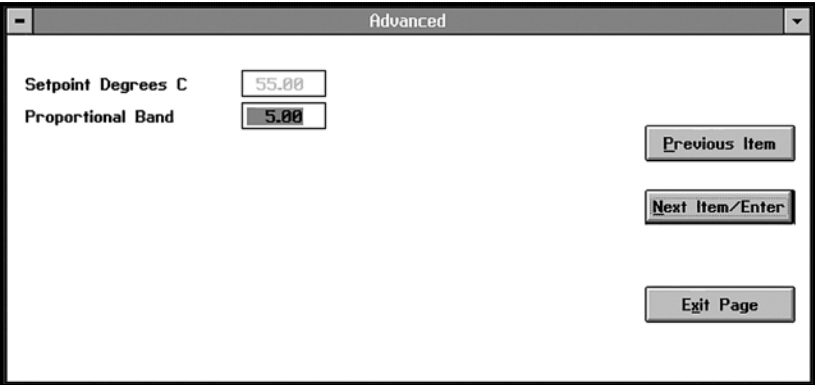

Figure 76: Proportional Band in the Heater Window

Enter the desired value and click on *Next Item/Enter* to confirm the entry.

The final command asks for the *Integral Time* in seconds, as shown in *Figure 77* below. Unless otherwise specified by GE, the Integral Time should be set at 200.00.

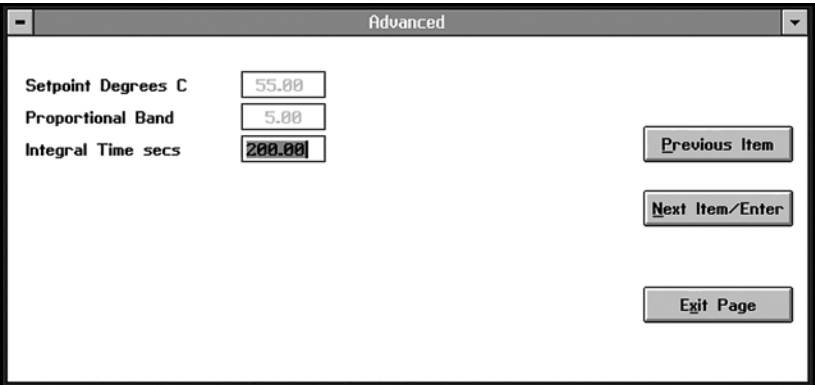

Figure 77: Integral Time secs in the Heater Window

Enter the desired number of seconds, and click on *Next Item/Enter* to confirm the entry and return to the *Advanced* window.

D.3 Balance Bridge

The window for the *Balance Bridge* command is similar to *Figure 78* below.

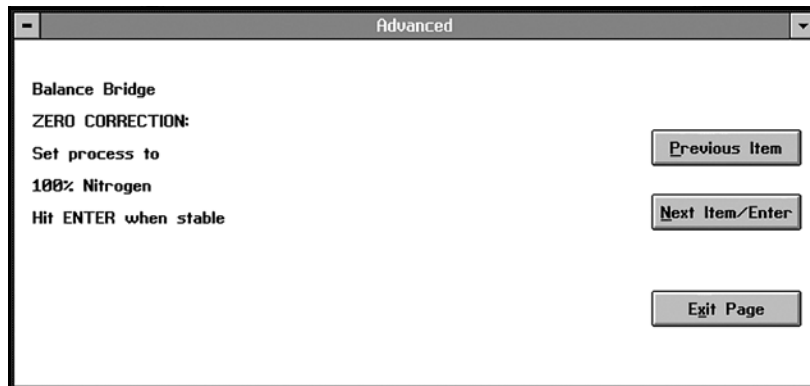

Figure 78: Balance Bridge Window

Click on *Next Item/Enter* after the bridge has reached stability. You can monitor stability in the *Real Time/Diagnostics* menu of IDM. The next window lists the selected thermal parameters, as shown in *Figure 79* below.

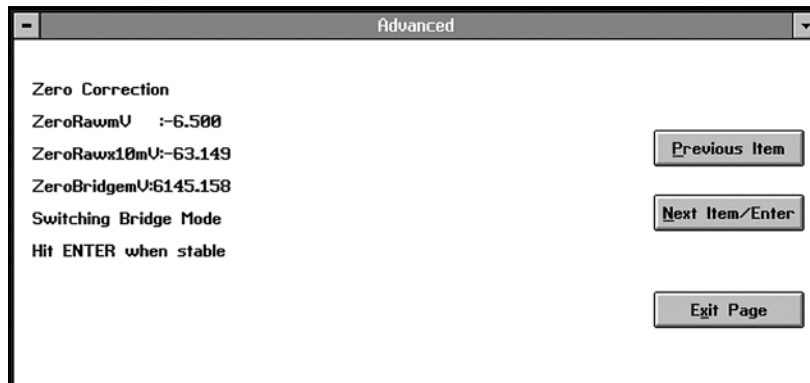

Figure 79: Zero Correction Window

D.3 Balance Bridge (cont.)

Click on *Next Item/Enter* to complete the balancing procedure. The window displays the thermal balance or imbalance diagnostic, as shown in *Figure 80* below.

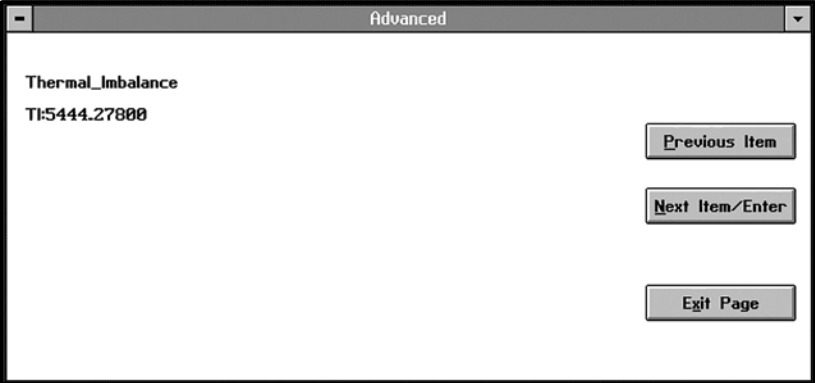

Figure 80: Thermal Balance (or Imbalance) Window

Click on *Next Item/Enter* to return to the *Advanced* window.

D.4 Factory Settings

The window for the *Factory Settings* command is similar to *Figure 81* below.

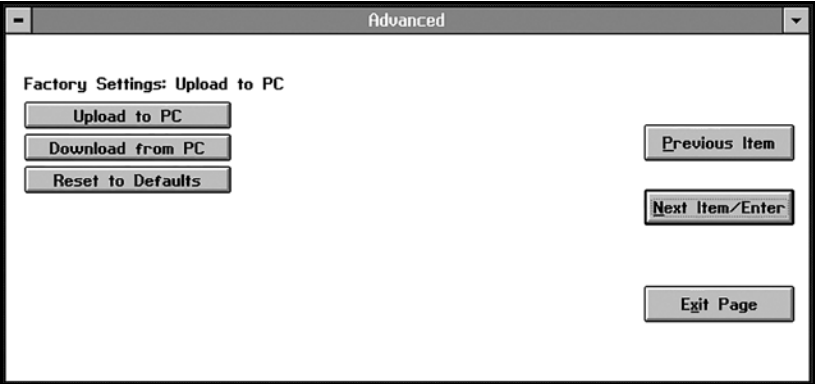

Figure 81: Factory Settings Command

D.4 Factory Settings (cont.)

If you click on *Upload to PC*, you are prompted to create a file, as shown in *Figure 82* below.

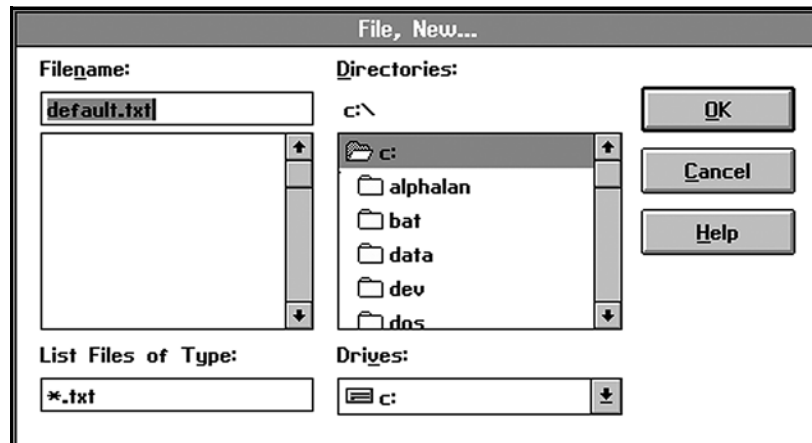

Figure 82: Creating a Data File

If you click on *Download from PC*, you are asked for a file name, as shown in *Figure 83* below.

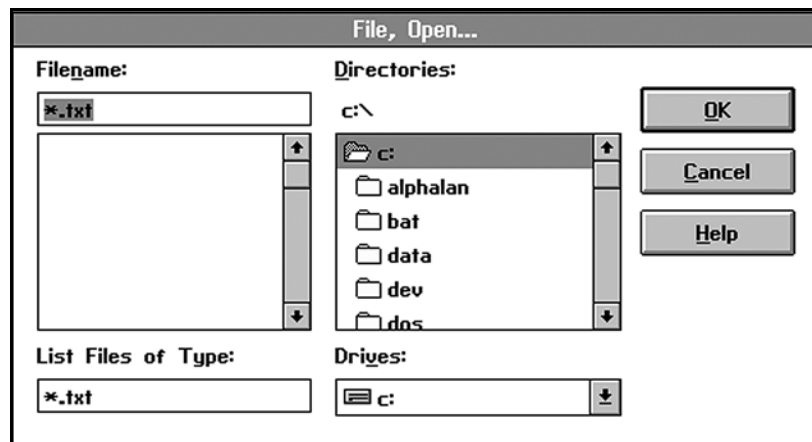

Figure 83: Downloading a Data File

However, if you click on *Reset to Defaults*, the status is displayed in the *Factory Settings* window. Click on *Next Item/Enter* to confirm the entry. (Click *Previous Item* or *Exit Page* to close the window without changing the status.)

D.5 Temperature Comp.

The window for the *Temperature Comp.* command is similar to *Figure 84* below.

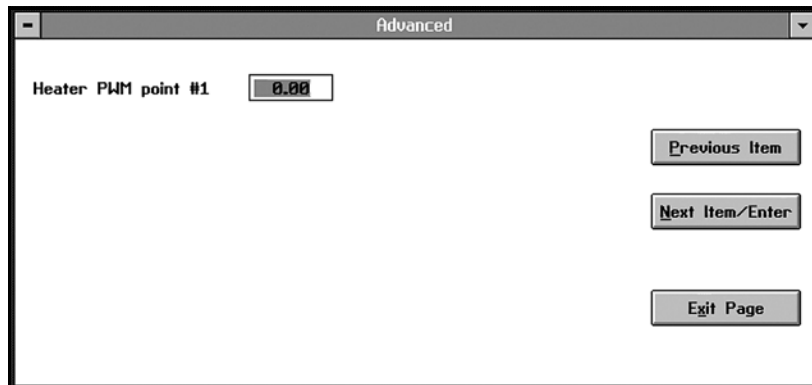

Figure 84: *Temperature Comp.* Window

The first command asks for the **PWM** (pulse-width-modulation) for **point #1**. PWM represents the ratio of the heater ON time to the heater OFF time. It acts to compensate for drift due to changes in ambient temperature. Enter the desired percentage of time the heater is ON, and click on *Next Item/Enter* to confirm the entry. (For any command, click *Previous Item* to return to the previous parameter, or *Exit Page* to close the window without changing any values.)

At the next command, as shown in *Figure 85* below, enter the **K-factor** (the compensation for the PWM percentage) for point #1.

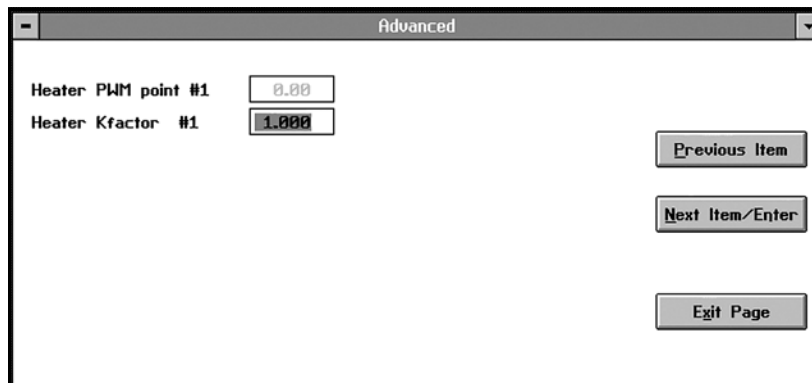

Figure 85: *K-factor* Window

D.5 Temperature Comp. (cont.)

At the next prompt, enter the K factor for the analog output, as shown in *Figure 86* below.

The screenshot shows a window titled "Advanced" with a dropdown arrow on the right. Inside the window, there are three rows of configuration items, each with a text label and a numeric input field:

- Heater PWM point #1: 0.00
- Heater Kfactor #1: 1.000
- Aout Kfactor #1: 1.000

To the right of these fields are three buttons: "Previous Item", "Next Item/Enter", and "Exit Page".

Figure 86: Aout K-factor Window

At the following series of prompts, enter the PWM point, the K-factor and the Aout K-factor for points #2 and #3. In each case, enter the desired value and click on *Next Item/Enter* to confirm the entry.

At the final prompt, as shown in *Figure 87* below, enter the **temperature mV K-factor**, a compensation to the bridge reading during ambient temperature transitions.

The screenshot shows a window titled "Advanced" with a dropdown arrow on the right. Inside the window, there are nine rows of configuration items, each with a text label and a numeric input field:

- Aout Kfactor #1: 1.000
- Heater PWM point #2: 50.00
- Heater Kfactor #2: 1.000
- Aout Kfactor #2: 1.000
- Heater PWM point #3: 100.00
- Heater Kfactor #3: 1.000
- Aout Kfactor #3: 1.000
- Temp mV Kfactor: 5.250

To the right of these fields are three buttons: "Previous Item", "Next Item/Enter", and "Exit Page".

Figure 87: Temperature mV Kfactor Window

Enter the desired number and click on *Next Item/Enter* to confirm the entry. You are then returned to the *Advanced* menu.

Appendix E. CE Mark Compliance

E.1 CE Mark Requirements



WARNING! CE Mark compliance is required for all units installed in EU countries.



WARNING! To meet CE Mark requirements, you must shield and ground all electrical cables as described in this section (see *Table 5* below).

Note: *If you follow the instructions in this section, your unit will comply with the EMC Directive.*

Table 5: Wiring Requirements for CE Mark Compliance

Connection	Termination Modification
Power/Analog Output	<ol style="list-style-type: none"> 1. When connecting the line power/analog output cable, select the cable entry closest to the terminal blocks. 2. Use shielded cable* to connect the line power and the 4-20mA analog output device to the XMTC. It is recommended to use GE P/N X4(*) or equivalent for all weatherproof installation, and GE P/N Z4(*) or equivalent for all explosion/flameproof installation. 3. Terminate the shield to the cable gland. It is recommended to use GE P/N 419-215 or equivalent for all weatherproof installation and GE P/N 419-217 or equivalent for all explosion/flameproof installation.
RS232 Output	<ol style="list-style-type: none"> 1. Use shielded cable* to interconnect the XMTC enclosure with any external I/O devices. It is recommended to use GE P/N 704-668-12 or equivalent for all weatherproof installation and GE P/N 704-1262-12 or equivalent for all explosion/flameproof installation. 2. Terminate the shield to the cable gland. It is recommended to use GE P/N 419-215 or equivalent for all weatherproof installation and GE P/N 419-217 or equivalent for all explosion/flameproof installation.
*Wires enclosed in a properly-grounded metal conduit do not require additional shielding.	



WARNING! Cable entries of an approved flameproof design are required. These must be installed according to the manufacturer's instructions. The choice of cable entry device may limit the overall installation category achieved.



WARNING! It is the responsibility of the user to ensure that all cable entry devices and covers are properly installed and secure prior to applying power to the XMTC.

E.2 EMI Filter Board

For CE compliance, an *EMI filter board* has been added to the XMTC (see *Figure 88* below). This board is connected internally to terminal block **TB1**. The *power* and *analog output* connections are now made to terminal block **TB3** on the EMI filter board. The RS232 *digital output* connections are made to terminal block **TB2**.



CAUTION! Do not make any connections to unassigned or unused terminals.

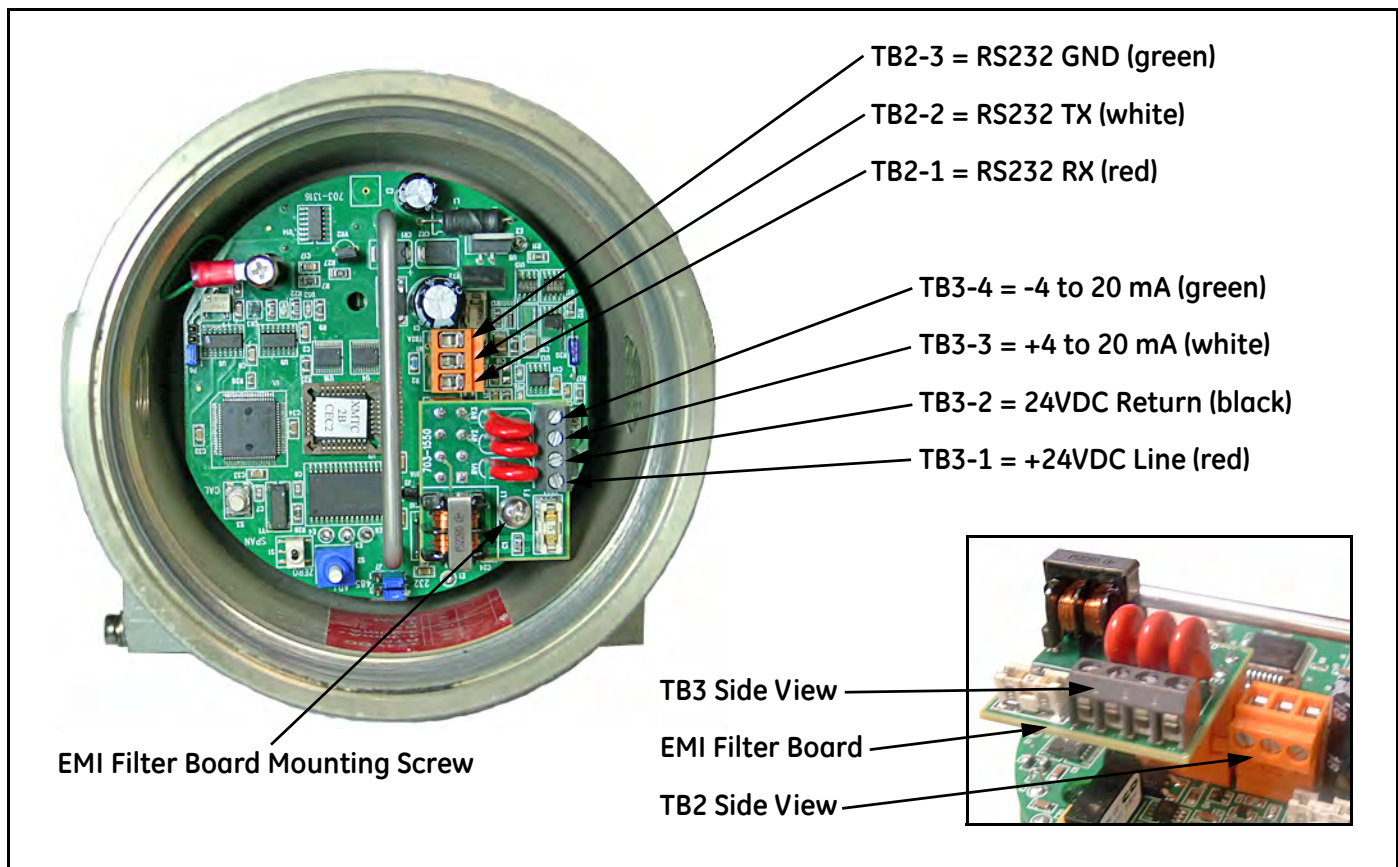

Figure 88: XMTC with EMI Filter Board - Wiring Connections

E.3 Wiring the Signal Connections for the Weatherproof Version

Refer to *Figure 88 on page 94*, and complete the following steps to make the proper wiring connections:



WARNING! Cable entries of an approved flameproof design are required. These must be installed according to the manufacturer's instructions. The choice of cable entry device may limit the overall installation category achieved.

1. Install the first cable entry device in accordance with the manufacturer's instructions.

Note: *If installation of the cable entry device is only partially complete, GE recommends tagging the device to ensure the safety of subsequent users.*

- a. Thread the cable gland entry body into the XMTC port closest to the terminal blocks.
- b. Route the 4-wire power/analog output cable through the cable gland as shown in *Figure 89* below.
- c. After terminating the shield as shown, assemble the three gland pieces together and tighten the gland to secure the cable and the shield.

IMPORTANT: *The cable shield must be terminated in the cable gland as shown in Figure 89 below.*

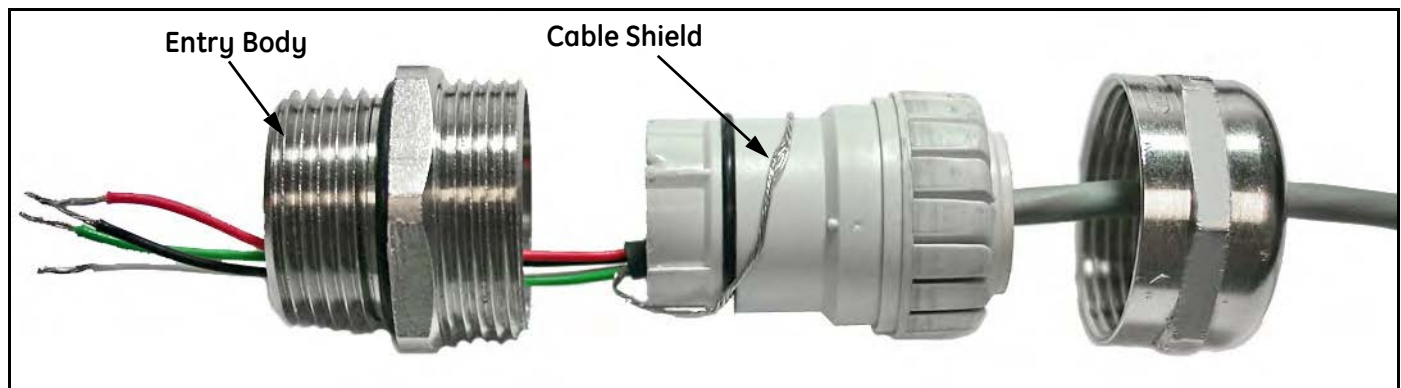

Figure 89: Proper Cable Gland Assembly (GE p/n 419-215)

2. Remove the screw that secures the EMI filter board to its standoff. Then, pull the board from its socket to access the TB3 connector, and loosen the terminal screws on the TB3 connector.
3. Connect the power leads:



CAUTION! Connecting the +24 VDC line (red) lead to any terminal except TB3-1 will damage the XMTC.

- a. Insert the 4-wire cable +24 VDC line (red) lead into pin TB3-1 and tighten the screw.
- b. Insert the 4-wire cable 24 VDC return (black) lead into pin TB3-2 and tighten the screw.
4. Connect the analog output leads:
 - a. Insert the 4-wire cable + 4-20 mA (white) lead into pin TB3-3 and tighten the screw.
 - b. Insert the 4-wire cable – 4-20 mA (green) lead into pin TB3-4 and tighten the screw.

E.3 Wiring the Signal Connections for the Weatherproof Version (cont.)

5. Carefully plug the EMI filter board back into its socket, and screw the EMI filter board to its standoff.
6. If you are installing the second cable entry device, do so in accordance with the manufacturer's instructions.

Note: *If installation of the cable entry device is only partially complete, GE recommends tagging the device to ensure the safety of subsequent users.*

- a. Thread the cable gland entry body into the remaining XMTC port.
- b. Route the 3-wire RS232 cable through the cable gland as shown in *Figure 89 on page 95*.
- c. After terminating the shield as shown, assemble the three gland pieces together and tighten the gland to secure the cable and the shield.

IMPORTANT: *The cable shield must be terminated in the cable gland as shown in Figure 89 on page 95.*

7. Unplug the TB2 connector by pulling it straight out of its socket, and loosen the terminal screws on the TB2 connector.
8. Connect the RS232 serial port leads:
 - a. Insert the 3-wire cable RX (red) lead into pin TB2-1 and tighten the screw.
 - b. Insert the 3-wire cable TX (white) lead into pin TB2-2 and tighten the screw.
 - c. Insert the 3-wire cable GND (green) lead into pin TB2-3 and tighten the screw.
9. Carefully plug the TB2 connector into its socket.
10. Reinstall the cover on the XMTC.
11. Connect the other ends of the cables to the 24 VDC power supply, the 4-20 mA input of the display device, and the serial port of the computer or terminal (see the instruction manuals for those devices for details).

E.4 Wiring the Signal Connections for the Explosion/Flameproof Version

Refer to *Figure 88 on page 94*, and complete the following steps to make the proper wiring connections:



WARNING! Cable entries of an approved flameproof design are required. These must be installed according to the manufacturer's instructions. The choice of cable entry device may limit the overall installation category achieved.

1. Install the first cable entry device in accordance with the manufacturer's instructions.

Note: *If installation of the cable entry device is only partially complete, GE recommends tagging the device to ensure the safety of subsequent users.*

- a. Remove the tab "Remove Before Installation".
- b. Thread the cable gland entry body into the XMTC port closest to the terminal blocks.
- c. Route the 4-wire power/analog output cable & its ground lug through the cable gland.
- d. Fray the braided shield and spread evenly around the cone as shown in *Figure 90* below. Compress the ring to lock the shield.
- e. After terminating the shield as shown, assemble the gland pieces together and tighten the gland to secure the cable and the shield.

IMPORTANT: *The cable shield must be terminated in the cable gland as shown in *Figure 90* below.*

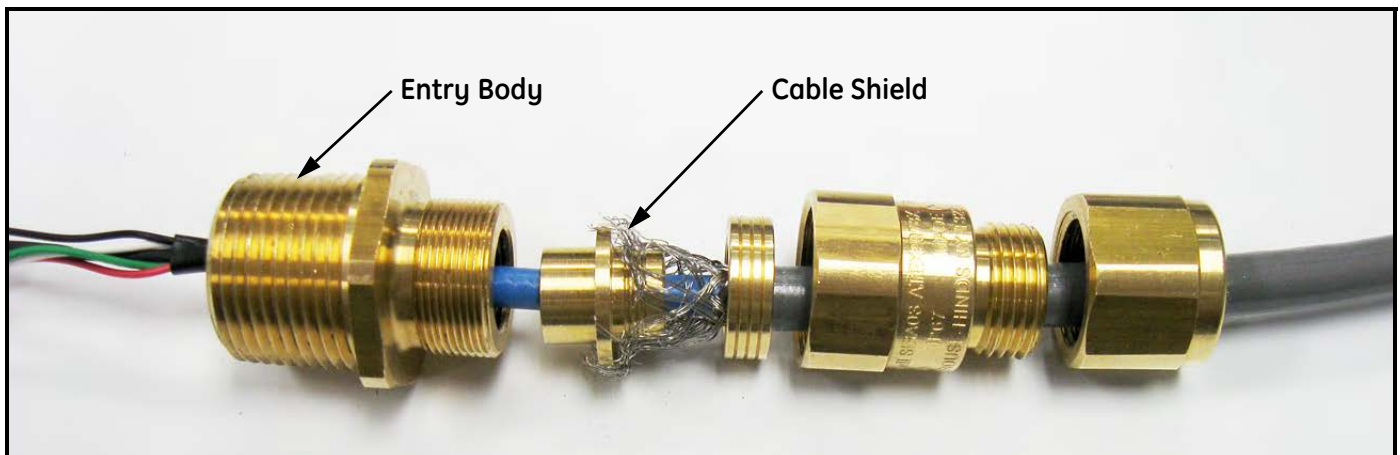

Figure 90: Proper Cable Gland Assembly (GE p/n 419-217)

2. Remove the standoff and the screw that secures the EMI filter board to its standoff. Then, pull the board from its socket to access the TB3 connector, and loosen the terminal screws on the TB3 connector.

E.4 Wiring the Signal Connections for the Explosion/Flameproof Version (cont.)

3. Connect the power leads:



CAUTION! Connecting the +24 VDC line (red) lead to any terminal except TB3-1 will damage the XMTC.

- a. Insert the 4-wire cable +24 VDC line (red) lead into pin TB3-1 and tighten the screw.
- b. b. Insert the 4-wire cable 24 VDC return (black) lead into pin TB3-2 and tighten the screw.
4. Connect the analog output leads:
 - a. Insert the 4-wire cable + 4-20 mA (white) lead into pin TB3-3 and tighten the screw.
 - b. Insert the 4-wire cable - 4-20 mA (green) lead into pin TB3-4 and tighten the screw.
5. Plug the EMI board back into its socket and secure it with the standoff. Terminate the ground lug of the cable to the standoff and secure it with the provided screw.
6. If you are installing the second cable entry device, do so in accordance with the manufacturer's instructions.

Note: *If installation of the cable entry device is only partially complete, GE recommends tagging the device to ensure the safety of subsequent users.*

- a. Remove the tab “Remove Before Installation”.
- b. Thread the cable gland entry body into the remaining XMTC port.
- c. Route the 3-wire RS232 cable & its ground lug through the cable gland.
- d. Fray the braided shield and spread evenly around the cone as shown in Figure 90 on page 97. Compress the ring to lock the shield.
- e. After terminating the shield as shown, assemble the gland pieces together and tighten the gland to secure the cable and the shield.

IMPORTANT: *The cable shield must be terminated in the cable gland as shown in Figure 90 on page 97.*

7. Unplug the TB2 connector by pulling it straight out of its socket, and loosen the terminal screws on the TB2 connector.
8. Connect the RS232 serial port leads:
 - a. Insert the 3-wire cable RX (red) lead into pin TB2-1 and tighten the screw.
 - b. Insert the 3-wire cable TX (white) lead into pin TB2-2 and tighten the screw.
 - c. Insert the 3-wire cable GND (green) lead into pin TB2-3 and tighten the screw.
9. Carefully plug the TB2 connector back into its sockets. Terminate the ground lug to the nearest standoff.
10. Reinstall the cover on the XMTC.
11. Connect the other ends of the cables to the 24 VDC power supply, the 4-20 mA input of the display device, and the serial port of the computer or terminal (see the instruction manuals for those devices for details).

Appendix F. Certifications

F.1 EC-Type Examination Certificate

	
<p>1. EC-TYPE EXAMINATION CERTIFICATE</p>	
<p>2. Equipment or Protective System Intended for use in Potentially Explosive Atmospheres Directive 94/9/EC</p>	
<p>3. EC-Type Examination Certificate Number:</p>	<p>ITS12ATEX17703X</p>
<p>4. Equipment or Protective System:</p>	<p>XMTC Gas Analyser and XMO2 Oxygen Analyser</p>
<p>5. Manufacturer:</p>	<p>GE Infrastructure Sensing</p>
<p>6. Address:</p>	<p>1100 Technology Park Drive, Billerica, MA, 01821</p>
<p>7. This equipment or protective system and any acceptable variation thereto is specified in the schedule to this certificate and the documents therein referred to.</p>	
<p>8. Intertek Testing and Certification Limited, notified body number 0359 in accordance with Article 9 of the Council Directive 94/9/EC of 23 March 1994, certifies that this equipment or protective system has been found to comply with the Essential Health and Safety Requirements relating to the design and construction of equipment and protective systems intended for use in potentially explosive atmospheres given in Annex II to the Directive.</p>	
<p>The examination and test results are recorded in confidential Intertek Report Ref 100911958MAN-001 dated July 2013.</p>	
<p>9. Compliance with the Essential Health and Safety Requirements has been assured by compliance with standards EN 60079-0:2012 and EN 60079-1:2007 except in respect of those requirements referred to at item 18 of the Schedule.</p>	
<p>10. If the sign "X" is placed after the certificate number, it indicates that the equipment or protective system is subject to special conditions for safe use specified in the schedule to this certificate.</p>	
<p>11. This EC-Type examination certificate relates only to the design and construction of the specified equipment or protective system in accordance to the directive 94/9/EC. Further requirements of the Directive apply to the manufacturing process and supply of this equipment or protective system. These are not covered by this certificate.</p>	
<p>12. The marking of the equipment or protective system shall include the following:-</p>	
	<p>II 2 G Ex d IIC T6 Gb (Tamb: -20°C to +65°C) for the XMTC (Tamb: -20°C to +55°C) for the XMO2</p>
<p>Intertek Testing & Certification Limited Intertek House, Cleeve Road, Leatherhead, Surrey, KT22 7SB Tel: +44 (0)1372 370900 Fax: +44 (0)1372 370977 www.intertek.com Registered No 3272281 Registered Office: Academy Place, 1-9 Brook Street, Brentwood, Essex, CM14 5NQ.</p>	 K R Spence Certification Officer 26 July 2013
<p>This certificate may only be reproduced in its entirety and without any change, schedule included and is subject to Intertek Testing and Certification's Conditions for Granting Certification.</p>	
<p>Sheet 1 of 3</p>	
<p>FxF-300 - FC Type Examination Certificate</p>	<p>Template Revision 4</p>
<p>June 2013</p>	



Figure 91: EC-Type Examination Certificate (Sheet 1 of 3)

F.1 EC-Type Examination Certificate (cont.)

<p>SCHEDULE EC-TYPE EXAMINATION CERTIFICATE NUMBER ITS12ATEX17703X</p>		
15. Description of Equipment or Protective System	<p>The XMTC and XMO2 are cylindrical flameproof enclosures that can be made from either stainless steel or a powder coated aluminium alloy. The equipment is approximately 140 mm in diameter and approximately 210mm from base to lid, excluding the protrusions used for opening and closing the enclosure and the flame arrestors on the bottom. The flame arrestors are certified and covered by certificate number ITS12ATEX90013U.</p> <p>The XMTC measures the concentration of a gas in a binary gas mixture by measuring the thermal conductivity of the sample gas and comparing it to the thermal conductivity of a selected reference gas. The XMO2 measures the concentration of oxygen in a gas mixture by utilizing the unique paramagnetic properties of oxygen. Both models utilise 3/4" NPT entries into the enclosures.</p> <p>The equipment is earthed internally and externally via screwed earthing connections and are clearly marked on the enclosures. Both the XMO2 and the XMTC are rated 24Vdc, 25 Watts.</p>	
16. Report Number	Intertek Report Ref: 100911958MAN-001 dated: July 2013	
17. Conditions of Certification	<p>(a) Special Conditions for safe use</p> <ul style="list-style-type: none"> • Only suitably approved Ex d IIC Gb cable glands and blanking elements suitable for the ambient temperature range shall be used. • No modifications must be made to the flamepaths of the unit without consultation of the manufactures drawings. <p>(b) Conditions of Manufacture</p> <ul style="list-style-type: none"> • None 	
18. Essential Health and Safety Requirements (EHSR's)	The relevant EHSR's have been identified and assessed in Intertek Report Ref: 100911958MAN-001 dated July 2013	
<p style="text-align: center;">Intertek Testing & Certification Limited Intertek House, Cleeve Road, Leatherhead, Surrey, KT22 7SB Tel: + 44 (0)1372 370900 Fax: +44 (0)1372 370977 www.intertek.com Registered No 3272281 Registered Office: Academy Place, 1-9 Brook Street, Brentwood, Essex, CM14 5NQ.</p>		
<p style="text-align: center;">This Certificate is the property of Intertek Testing and Certification Ltd and is subject to Intertek Testing and Certification's Conditions for Granting Certification.</p>		
Sheet 2 of 3		
ExF-300 - EC Type Examination Certificate	Template Revision 4	June 2013

Figure 92: EC-Type Examination Certificate (Sheet 2 of 3)

F.1 EC-Type Examination Certificate (cont.)

			
SCHEDULE			
EC-TYPE EXAMINATION CERTIFICATE NUMBER ITS12ATEX17703X			
19. Drawings and Documents			
Number	Title	Issue	Date
752-168	Certification Drawing XMO2, XMTC (Sheets 1 to 4)	E	12/1/12
910-141	Certification & Safety Statements for the XMO2 Oxygen Analyser (Sheets 1 & 2)	A	May 2013
CSS-0006	Certification & Safety Statements for the XMTC Gas Analyser (Sheets 1 & 2)	A	May 2013

This Certificate is for the exclusive use of Intertek's client and is provided pursuant to the agreement between Intertek and its Client. Intertek's responsibility and liability are limited to the terms and conditions of the agreement. Intertek assumes no liability to any party, other than to the Client in accordance with the agreement, for any loss, expense or damage occasioned by the use of this Certificate. Only the Client is authorized to permit copying or distribution of this Certificate and then only in its entirety. Any use of the Intertek name or one of its marks for the sale or advertisement of the tested material, product or service must first be approved in writing by Intertek.

Intertek Testing & Certification Limited
Intertek House, Cleeve Road, Leatherhead, Surrey, KT22 7SB
Tel: + 44 (0)1372 370900 Fax: +44 (0)1372 370977
www.intertek.com
Registered No 3272281 Registered Office: Academy Place, 1-9 Brook Street, Brentwood, Essex, CM14 5NQ.

This Certificate is the property of Intertek Testing and Certification Ltd and is subject to Intertek Testing and Certification's Conditions for Granting Certification.

Sheet 3 of 3

ExF-300 - EC Type Examination Certificate Template Revision 4 June 2013

Figure 93: EC-Type Examination Certificate (Sheet 3 of 3)

F.2 IECEx Certificate of Conformity



		<h1>IECEx Certificate of Conformity</h1>	
INTERNATIONAL ELECTROTECHNICAL COMMISSION IEC Certification Scheme for Explosive Atmospheres <small>for rules and details of the IECEx Scheme visit www.iecex.com</small>			
Certificate No.:	IECEx ITS 12.0058X	issue No.:0	Certificate history:
Status:	Current		
Date of Issue:	2013-07-23	Page 1 of 3	
Applicant:	GE Infrastructure Sensing 1100 Technology Park Drive Billerica, MA,01821 United States of America		
Electrical Apparatus: <i>Optional accessory:</i>	XMTC and XMO2		
Type of Protection:	Flameproof 'Ex d', Protection by Enclosure		
Marking:	XMTC = Ex d IIC T6 Gb (T _{amb} -20°C to +65°C) XMO2 = Ex d IIC T6 Gb (T _{amb} -20°C to +55°C)		
	IECEx ITS 12.0058X		
Approved for issue on behalf of the IECEx Certification Body:	K R Spence		
Position:	Certification officer		
Signature: <i>(for printed version)</i>			
Date:			
	1. This certificate and schedule may only be reproduced in full. 2. This certificate is not transferable and remains the property of the issuing body. 3. The Status and authenticity of this certificate may be verified by visiting the Official IECEx Website .		
Certificate issued by:	Intertek Testing & Certification Limited ITS House, Cleeve Road, Leatherhead, Surrey, KT22 7SB United Kingdom		

Figure 94: EC-Type Examination Certificate (Page 1 of 3)

F.2 IECEx Certificate of Conformity (cont.)

		<h1>IECEx Certificate of Conformity</h1>	
Certificate No.:	IECEX ITS 12.0058X		
Date of Issue:	2013-07-23	Issue No.:	0
			Page 2 of 3
Manufacturer:	GE Infrastructure Sensing 1100 Technology Park Drive Billerica, MA,01821 United States of America		
Additional Manufacturing location (s):	GE Sensing EMEA Unit A/B Shannon Free Zone East Shannon County Clare Ireland Ireland		
<p>This certificate is issued as verification that a sample(s), representative of production, was assessed and tested and found to comply with the IEC Standard list below and that the manufacturer's quality system, relating to the Ex products covered by this certificate, was assessed and found to comply with the IECEx Quality system requirements. This certificate is granted subject to the conditions as set out in IECEx Scheme Rules, IECEx 02 and Operational Documents as amended.</p>			
<p>STANDARDS: The electrical apparatus and any acceptable variations to it specified in the schedule of this certificate and the identified documents, was found to comply with the following standards:</p>			
<p>IEC 60079-0 : 2011 Explosive atmospheres - Part 0: General requirements Edition: 6.0</p>			
<p>IEC 60079-1 : 2007-04 Explosive atmospheres - Part 1: Equipment protection by flameproof enclosures "d" Edition: 6</p>			
<p><i>This Certificate does not indicate compliance with electrical safety and performance requirements other than those expressly included in the Standards listed above.</i></p>			
<p>TEST & ASSESSMENT REPORTS: A sample(s) of the equipment listed has successfully met the examination and test requirements as recorded in</p>			
<p><u>Test Report:</u> GB/ITS/ExTR12.0059/00</p>			
<p><u>Quality Assessment Report:</u> GB/BAS/QAR06.0025/04 GB/BAS/QAR10.0026/01</p>			

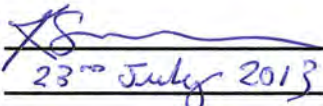
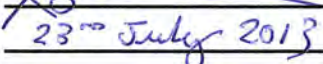
Figure 95: EC-Type Examination Certificate (Page 2 of 3)

F.2 IECEx Certificate of Conformity (cont.)

		<h2 style="margin: 0;">IECEx Certificate of Conformity</h2>	
Certificate No.:	IECEx ITS 12.0058X	Issue No.:	0
Date of Issue:	2013-07-23	Page 3 of 3	
Schedule			
EQUIPMENT:			
<i>Equipment and systems covered by this certificate are as follows:</i>			
<p>The XMTC and XMO2 are cylindrical flameproof enclosures that can be made from either stainless steel or a powder coated aluminium alloy. The equipment is approximately 140 mm in diameter and approximately 210mm from base to lid, excluding the protrusions used for opening and closing the enclosure and the flame arrestors on the bottom. The flame arrestors are certified and covered by certificate number IECExINE12.0002U.</p> <p>The XMTC measures the concentration of a gas in a binary gas mixture by measuring the thermal conductivity of the sample gas and comparing it to the thermal conductivity of a selected reference gas. The XMO2 measures the concentration of oxygen in a gas mixture by utilizing the unique paramagnetic properties of oxygen. Both models utilise 3/4" NPT entries into the enclosures. The equipment is earthed internally and externally via screwed earthing connections and are clearly marked on the enclosures. Both the XMO2 and the XMTC are rated 24Vdc, 25 Watts.</p>			
CONDITIONS OF CERTIFICATION: YES as shown below:			
<ul style="list-style-type: none"> ■ Only suitably approved Ex d IIC Gb cable glands and blanking elements suitable for the ambient temperature range shall be used. ■ No modifications must be made to the flamepaths of the unit without consultation of the manufactures drawings. 			
<p>Annex: Annex to IECEx ITS 12. 0058X issue 0.doc</p>			

Figure 96: EC-Type Examination Certificate (Page 3 of 3)

A			
Accessories	51	Certifications	
Advanced Option		ATEX Certification	99
Basic	37	EC-Type Examination Certificate	99
Enhanced	85	IECEX Certificate of Conformity	102
Ambient Temperature Range	50	Clear Calibration	27
Analog Output		Configure Cal	23
Calibration	29		
Configuration	28	D	
Specifications	50	Date of Publication	i
Testing	30	Dimensions	50
Applications		Displays	
Heat Treat Furnace Atmospheres	59	TMO2D-TC	6
Hydrogen-Cooled Generators	64	XDP	6
Typical	7, 59	Document Number	i
ATEX Certification	99	Drawings, Installation & Wiring	69
		Drift/Cal Error.	33
C		Drifts, Calibration	26
Cable			
Available Options	51	E	
Entry Devices	19, 93	EC-Type Examination Certificate	99
GE Standard	6	Edit Functions, IDM Menu.	20
Specifications	50	EMC Directive	93
Calibration		EMI Filter Board	94
Analog Output	29	Enclosure	
Clear	27	Flowing Reference	5
Configure Cal	23	Options	3
Data Sheet	56	Sealed Reference	4
Drifts	26	Environmental	
Factory Cal	35	Specifications	50
Field Cal	21	Environmental Compliance	iv
Flowing Reference XMTC	47	Error	
Gas Ranges & Types	43	Drift/Cal	33
Interval	43	Total Drift	32
Ordering String	54	Error Handler	31
Preparing the Transmitter	45		
Required Materials	44	F	
Sealed Reference XMTC	46	Factory Cal	35
Switch Location	46	Factory Settings Command	89
Calibration Sheet	56	Fast Response	38
CE Mark Compliance	93	Field Cal	21
		Filter Board, EMI	94
		Flow Rate, Gas	49

Flowing Reference		Physical Specifications	50
Calibration	47	Power Specifications	50
Enclosure	5	Power Supply	6
Functional Specifications	50	Powering Up	19
		Programming	
G		Enhanced Advanced Option	85
Gas		IDM	20
Flow Rates	49	Menu Maps	41
Ranges & Types	43	Password	37
Sample Gas Flow Rate	19		
		R	
H		Ranges, Measurement	49
Hold Last Value	27	Return Policy	109
I		S	
IDM Programming	20	Safety	
IECEX Certificate of Conformity	102	Auxiliary Equipment	iii
Information Paragraphs	iii	General Issues	iii
Installation		Personal Equipment	iv
Drawings	69	Sample System, Basic Requirements	6
Sample System	10	Sealed Reference	
XMTC	9	Calibration	46
Interval for Calibration	43	Enclosure	4
		Signal Connections	
L		CE Wiring	95
Language Selection	38	Signal Connections, Wiring	14
		Spare Parts Numbers	55
M		Specifications	
Measurement Ranges	49	Environmental	50
Menu Maps, Programming	41	Functional	50
Meter ID	40	Performance	49
Model Number	53	Physical	50
		Switch Location, Calibration	46
N			
Network ID	40	T	
		Testing	
O		% Gas	31
Operating Temperature	50	Analog Output	30
Ordering String		Theory of Operation	2
Calibration	54	Thermal Conductivity	
XMTC	53	Common Gases	2
		Table of Values	57
P		TMO2D-TC Optional Display	6
Parts Numbers	55	Total Drift Error	32
Password, Programming	37		
Performance Specifications	49		

Typical Applications 7, 59

U

Under/Over Range. 34

W

Warranty 109

WEEE Directive iv

Weight 50

Wiring

CE Mark Compliance. 93

CE Signal Connections. 95

Drawings. 69

External Devices 17

Instructions 12

Signal Connections 14

X

XDP Optional Display 6

[no content intended for this page]

Warranty

Each instrument manufactured by GE Sensing is warranted to be free from defects in material and workmanship. Liability under this warranty is limited to restoring the instrument to normal operation or replacing the instrument, at the sole discretion of GE Sensing. Fuses and batteries are specifically excluded from any liability. This warranty is effective from the date of delivery to the original purchaser. If GE Sensing determines that the equipment was defective, the warranty period is:

- one year from delivery for electronic or mechanical failures
- one year from delivery for sensor shelf life

If GE Sensing determines that the equipment was damaged by misuse, improper installation, the use of unauthorized replacement parts, or operating conditions outside the guidelines specified by GE Sensing, the repairs are not covered under this warranty.

The warranties set forth herein are exclusive and are in lieu of all other warranties whether statutory, express or implied (including warranties or merchantability and fitness for a particular purpose, and warranties arising from course of dealing or usage or trade).

Return Policy

If a GE Sensing instrument malfunctions within the warranty period, the following procedure must be completed:

1. Notify GE Sensing, giving full details of the problem, and provide the model number and serial number of the instrument. If the nature of the problem indicates the need for factory service, GE Sensing will issue a RETURN AUTHORIZATION NUMBER (RAN), and shipping instructions for the return of the instrument to a service center will be provided.
2. If GE Sensing instructs you to send your instrument to a service center, it must be shipped prepaid to the authorized repair station indicated in the shipping instructions.
3. Upon receipt, GE Sensing will evaluate the instrument to determine the cause of the malfunction.

Then, one of the following courses of action will then be taken:

- If the damage is covered under the terms of the warranty, the instrument will be repaired at no cost to the owner and returned.
- If GE Sensing determines that the damage is not covered under the terms of the warranty, or if the warranty has expired, an estimate for the cost of the repairs at standard rates will be provided. Upon receipt of the owner's approval to proceed, the instrument will be repaired and returned.

[no content intended for this page]

Certification & Safety Statements for the XMTC Gas Analyzer

When installing this apparatus, the following requirements must be met:

- Field wiring shall be rated at least 10°C above 65°C.
- Connecting cables shall be mounted securely and protected from mechanical damage, pulling and twisting.
- Cable entries are ¾" NPT.
- Cable glands of an approved flameproof design, ATEX + IECEx rated Ex d IIC, are required. These must be installed according to the manufacturer's instructions. Where the cable glands are provided by GE, the manufacturer's instructions, as supplied, to GE, will be included in the documentation.
- Unused entries must be sealed using a certified, ATEX + IECEx rated Ex d IIC, threaded plug.
- Modifications to the flameproof enclosure are not permitted.
- The apparatus should be de-energized before opening.
- Installation should comply with IEC/EN 60079-14.
- Equipment is of type flameproof "d" design and complies with: EN 60079-0:2012, EN 60079-1:2007, EN 60529:1991 +A1:2000, IEC 60079-0:2011, IEC 60079-1:2007, IEC 60529:2001.
- The product contains no exposed parts which produce surface temperature infrared, electromagnetic ionizing, or non-electrical dangers.
- The product must not be subjected to mechanical or thermal stresses in excess of those permitted in the certification documentation and the instruction manual.
- The product cannot be repaired by the user; it must be replaced by an equivalent certified product. Repairs should only be carried out by the manufacturer or by an approved repairer.
- Only trained, competent personnel may install, operate and maintain the equipment.
- Replacement of Cells or Batteries is not permitted by the end user.
- The Battery is protected from Stray Voltage by the Microprocessor Supervisory Circuit (see image to right).
- The product is an electrical apparatus and must be installed in the hazardous area in accordance with the requirements of the EC Type Examination Certificate. The installation must be carried out in accordance with all the appropriate international, national and local standard codes and practices and site regulations for flameproof apparatus and in accordance with the instructions contained in the manual. Access to the circuitry must not be made during operation.

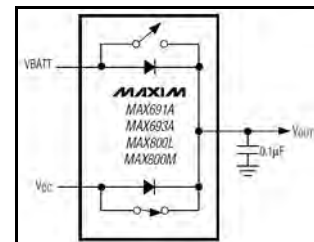

Special Conditions for Safe Use

- Consult the manufacturer if dimensional information on the flameproof joints is necessary.

Markings

- Markings shall appear on the product as shown below:

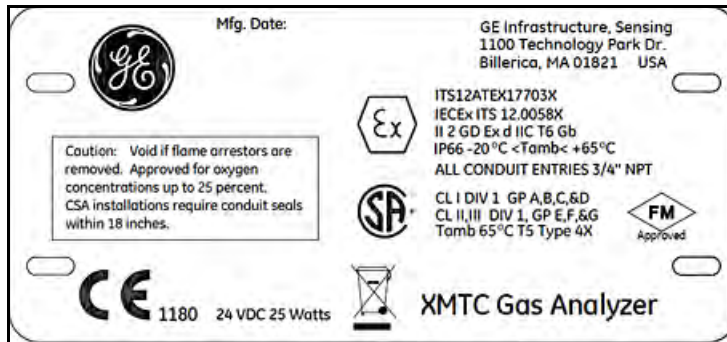

We,

**GE Sensing
1100 Technology Park Drive
Billerica, MA 01821
USA**

declare under our sole responsibility that the

**XMO2 Oxygen Analyzer
XMTC Thermal Conductivity Binary Gas Transmitter**

to which this declaration relates, are in conformity with the following standards:

- IECEx 60079-0: 2011 & EN 60079-0: 2012
- IECEx 60079-1: 2007 & EN 60079-0: 2007
- EN 50281-1-1: 1998
- EN 61326-1: 2006, Class A, Table 2, Industrial Locations
- EN 61326-2-3: 2006
- EN 61010-1: 2001, Overvoltage Category II, Pollution Degree 2

Other standards Used:

- EN 50014: 1997 +A1, A2, A3
- EN 50018: 2000

following the provisions of the 2004/108/EC EMC, 2006/95/EC Low Voltage and 94/9/EC ATEX Directives.

Where products were initially assessed for compliance with the Essential Health and Safety Requirements of the ATEX Directive 94/9/EC using earlier harmonized standards, a subsequent review has determined that "technical knowledge" is unaffected by the current harmonized standards listed above.

The units listed above and any ancillary equipment supplied with them do not bear CE marking for the Pressure Equipment Directive, as they are supplied in accordance with Article 3, Section 3 (sound engineering practices and codes of good workmanship) of the Pressure Equipment Directive 97/23/EC for DN<25.

Billerica - June 2013

Issued



[no content intended for this page]

Customer Support Centers

U.S.A.

The Boston Center
1100 Technology Park Drive
Billerica, MA 01821
U.S.A.
Tel: 800 833 9438 (toll-free)
978 437 1000
E-mail: sensing@ge.com

Ireland

Sensing House
Shannon Free Zone East
Shannon, County Clare
Ireland
Tel: +353 (0)61 470291
E-mail: gesensingsnnservices@ge.com

An ISO 9001:2008 Certified Company

www.ge-mcs.com/en/about-us/quality.html

www.ge-mcs.com

©2013 General Electric Company. All rights reserved.
Technical content subject to change without notice.